

**(DE) ACHTUNG!**

Vor Beginn der Montagearbeiten lesen Sie bitte aufmerksam die Sicherheitshinweise!

**(EN) WARNING!**

Before assembling, please read carefully the safety instructions!

**(NL) LET OP!**

Lees de veiligheidsinstructies zorgvuldig door voordat u met de montage begint!

**(FR) ATTENTION!**

Avant le début des travaux de montage, prière de lire attentivement les consignes de sécurité

**(IT) ATTENZIONE!**

Prima di installare leggere attentamente l'avviso di sicurezza!

**(ES) ATENCIÓN!**

Antes de comenzar con los trabajos de montaje leer detenidamente los avisos de seguridad!

**(PL) UWAGA!**

Przed przystąpieniem do prac montażowych uważnie należy przeczytać wskazówki bezpieczeństwa!

**(FI) HUOMIO!**

Ennen asennustöiden aloittamista pyydämme Teitä lukemaan turvaohjeet huolellisesti!

**(CZ) POZOR!**

Než začnete provádět montážní práce, přečtěte si důkladně bezpečnostní pokyny!

**(RU) ВНИМАНИЕ!**

До начала монтажных работ внимательно прочтите эти указания по технике безопасности!

**(GR) ΠΡΟΣΟΧΗ!**

Πριν την διεξαγωγή της συναρμολόγησης διαβάστε προσεκτικά τις υποδείξεις ασφαλείας!

**(RO) ATENȚIUNE!**

A se citi cu atenție indicațiile privind siguranța, înainte de începerea montării!

**(BG) ВНИМАНИЕ!**

Преди Да Започнете работите по монтажа прочетете ВНИМАТЕЛНО указанията За безопасност!

**(TR) DİKKAT!**

Montaja başlamadan önce güvenlik talimatnamesini titizlikle okuyunuz!

**(HU) FIGYELEM!**

A szerelési munkák megkezdése előtt figyelmesen olvassa el a biztonsági útmutatásokat!

**(SV) OBS!**

Läs säkerhetsanvisningarna noga innan du börjar med monteringsarbetena!

**(HR) POZOR!**

Prije početka montaže molimo pozorno pročitajte sigurnosne naputke!

**(SL) POZOR!**

Prosim, da pred začetkom montaze, zaradi varnosti preberete vas navodila, ki so priložena!

**(SK) POZOR!**

Pred tým ako začnete robiť montážne práce, prečítajte si dôkladne bezpečnostné pokyny!

**(PT) CUIDADO!**

Antes de iniciar os trabalhos de montagem por favor leia atentamente os avisos de segurança!

**(BA) POZOR!**

Prije početka montaže molimo pažljivo pročitajte sigurnosne upute!

**(LT) DĖMESIO!**

Norėdami saugiai ir teisingai sumontuoti šviestuvą vadovaukitės šia instrukcija!

**(ET) HOIATUS!**

Enne monteerimist lugege ohutusjuhised tähelepanelikult läbi!

**(DA) OBS!**

Læs sikkerhedsinformationen nøje, før du monterer produktet!

**(NO) ADVARSEL!**

Les sikkerhetsinformasjonen nøye før du monterer produktet!

**(LV) UZMANĪBU!**

Pirms montāžas uzmanīgi izlasiet drošības norādījumus!

**(SR) UPOZORENJE!**

Prije početka montaže, pažljivo pročitajte sigurnosne upute!

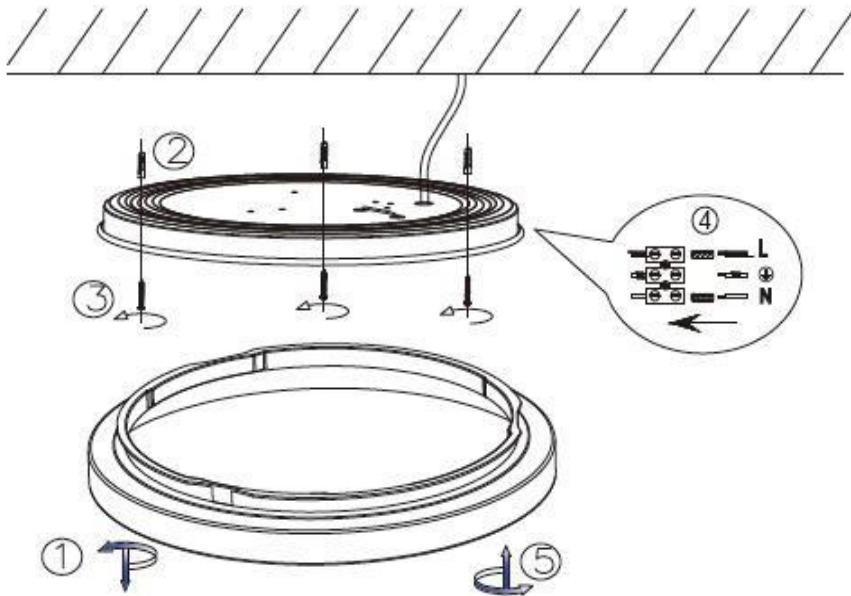

Battery  x 3







230V ~ 50Hz, LED 12W



reality-leuchten.de/  
R67111200

**DE**

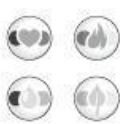





Die Leuchte darf nicht an einen externen Dimmer betrieben werden.  
Das System ist beim Einschalten am Wandschalter immer auf warm-weiß eingestellt

	<p>Drücken Sie die ON-Taste, um das Gerät einzuschalten. Drücken Sie die OFF-Taste, um sie auszuschalten.</p>
	<p>Schalten Sie das System auf Behaglich-Weiß, Warm-Weiß und Tageslicht um.</p>
	<p>Drücken Sie die Taste, um den Nachtlichtmodus zu starten.</p>
	<p>Drücken Sie die Taste, um den zufälligen Farbwechselmodus zu starten.</p>
	<p>Durch Drücken einer der vier voreingestellten Farbwechsellasten wird automatisch ein vorprogrammierter Zyklus mit mindestens 16 Farbtönen gestartet. Taste Romance Modus - Blau wechselt allmählich in den Rot; Taste Ocean Modus - Grün wechselt allmählich in Blau; Taste Fire Modus - Rot wechselt allmählich in Gelb; Taste Forest Modus - Gelb wechselt allmählich in Grün.</p>
	<p>Drücken Sie eine der Hauptfarbtasten am Farbrad. Durch Drücken einer Taste in der Nähe wird die Farbe allmählich geändert.</p>
	<p>Helligkeitseinstellung (funktioniert für die Farbmodi mit Ausnahme des Nachtlichts, des Zufallsfarbmodus und der 4 voreingestellten Farbwechsellasten).</p>

**EN**

The light is not to be operated with an external dimmer.







The system is always set to warm-white when switched on at the wall switch.

	Press the ON button to switch the device on. Press the OFF button to switch it off.
	Switch system to “cozy white”, “warm white” and “daylight”.
	Press the button to start nightlight mode.
	Press the button to start random color change mode.
	By pressing one of the four preset color changing buttons, a pre-programmed cycle (with at least 16 color cycles) starts automatically.  Button “romance mode” – blue gradually changes to red; Button “ocean mode” – green gradually changes to blue; Button “fire mode” – red gradually changes to yellow; Button “forest mode” – yellow gradually changes to green.
	Press one of the main color buttons on the color wheel. Pressing a nearby button will gradually change the color.
	Brightness adjustment (will work for the color modes except the nightlight, random color mode and the 4 preset color changing buttons).

**NL**

De lamp mag niet bediend worden met een externe dimmer.







Het systeem is altijd ingesteld op warm wit wanneer het ingeschakeld wordt met de muurschakelaar.

	Druk op de AAN-knop om het apparaat aan te zetten. Druk op de UIT-knop om het uit te zetten.
	Schakel het systeem op “gezellig wit”, “warm wit” en “daglicht”.
	Druk op de knop om naar nachtlampmodus te schakelen.
	Druk op de knop om naar de willekeurige kleurveranderingsmodus te schakelen.
	Door op een van de vier vooraf ingestelde kleurveranderingsknoppen te drukken begint er automatisch een vooraf geprogrammeerde cyclus (met minstens 16 kleurcycli).  Knop “romantische modus” – blauw verandert geleidelijk naar rood; Knop “oceanmodus” – groen verandert geleidelijk naar blauw; Knop “vuurmodus” – rood verandert geleidelijk naar geel; Knop “bosmodus” – geel verandert geleidelijk naar groen.
	Druk op een van de hoofdkleurknoppen op het kleurenwiel. Door op een nabije knop te drukken zal de kleur geleidelijk veranderen.
	Aanpassing van de felheid (zal werken voor de kleurmodi, behalve voor nachtlucht, willekeurige kleurenmodus en de 4 vooraf ingestelde kleurveranderingsknoppen).

## FR

L'éclairage ne doit pas être utilisé avec un gradateur externe.







Le système est toujours réglé sur blanc chaud lorsqu'il est allumé au niveau de l'interrupteur mural.

	Appuyez sur le bouton ON pour allumer l'appareil. Appuyez sur le bouton OFF pour l'éteindre.
	Commutez le système sur "blanc agréable", "blanc chaleureux" et "lumière de jour".
	Appuyez sur le bouton pour allumer le mode veilleuse.
	Appuyez sur le bouton pour activer le mode de changement de couleur aléatoire.
	En appuyant sur l'un des quatre boutons de changement de couleur préprogrammés, un cycle préprogrammé (avec au moins 16 cycles de couleur) démarre automatiquement. Bouton "mode romantique" – le bleu devient progressivement rouge ; bouton "mode océan" – le vert devient progressivement bleu ; bouton "mode feu" – le rouge devient progressivement jaune ; bouton "mode forêt" – le jaune devient progressivement vert.
	Appuyez sur l'un des boutons de couleur principale de la roue de couleur. Appuyez sur un bouton à proximité pour changer graduellement la couleur.
	Réglage de la luminosité (fonctionne pour les modes couleur, à l'exception du mode veilleuse, du mode couleur aléatoire et des 4 boutons de changement de couleur pré-réglés).

## IT

La luce non deve essere azionata con un variatore esterno.







Il sistema è sempre impostato su luce bianca calda quando si accende tramite l'interruttore a parete.

	Premere il pulsante ON per accendere il dispositivo. Premere il pulsante OFF per spegnerlo.
	Impostare il sistema su (cozy white) "bianco d'atmosfera", (warm white) "bianco caldo" e (daylight) "luce naturale".
	Premere il pulsante per attivare la modalità di illuminazione notturna.
	Premere il pulsante per attivare la modalità di modifica casuale del colore.
	Premendo uno dei quattro pulsanti di modifica del colore pre-impostati, si avvia automaticamente un ciclo pre-programmato (con almeno 16 cicli di colore). Pulsante (romance mode) "modalità romantica" - il blu passa gradualmente al rosso; pulsante (ocean mode) "modalità oceano" - il verde passa gradualmente al blu; pulsante (fire mode) "modalità fiamma" - il rosso passa gradualmente al giallo; pulsante (forest mode) "modalità foresta" - il giallo passa gradualmente al verde.
	Premere uno dei pulsanti colore principali sulla ruota dei colori. Premendo un pulsante vicino si cambia gradualmente il colore.
	Regolazione della luminosità (funziona per le modalità colore, ad eccezione della luce notturna, della modalità casuale del colore e dei 4 pulsanti di modifica del colore pre-impostati).

**ES**

La luz no se puede controlar con un dimmer externo.







El sistema siempre se ajusta a blanco cálido cuando se enciende con el interruptor de pared.

	Pulse el botón ON para encender el dispositivo. Pulse el botón OFF para apagarlo.
	Cambie el sistema a "blanco íntimo", "blanco cálido" y "luz diurna".
	Pulse el botón para cambiar al modo de luz nocturna..
	Pulse el botón para cambiar al modo de cambio de color aleatorio.
	Al pulsar uno de los cuatro botones de cambio de color predefinido, se pondrá en marcha automáticamente un ciclo preprogramado (con 16 ciclos de color como mínimo). Botón "modo romántico": el azul cambia a rojo gradualmente; Tecla "modo océano": el verde cambia a azul gradualmente; Botón "modo bosque": el amarillo cambia a verde gradualmente.
	Pulse uno de los colores principales de la rueda de colores. Al pulsar uno de los botones, el color cambiará gradualmente.
	Ajuste de brillo (funciona con los modos de color, excepto en el modo de luz nocturna y de color aleatorio y en los 4 botones de cambio de color predefinido).

**PL**

Światła nie należy włączać za pomocą zewnętrznego ściemniacza.







System jest zawsze ustawiony na ciepły biały po włączeniu go na przełączniku ściennym.

	Urządzenie włącza się przez naciśnięcie przycisku ON. Wyłącza się je przyciskiem OFF
	Przełączanie systemu w tryb „komfortowy biały”, „ciepły biały” i „światło dzienne”.
	Naciśnięcie przycisku powoduje przełączenie w tryb nocny
	Naciśnięcie przycisku powoduje przełączenie w tryb losowej zmiany kolorów
	Naciśnięcie jednego z czterech predefiniowanych przycisków zmiany kolorów powoduje automatyczne uruchomienie zaprogramowanego cyklu (z co najmniej 16 cyklami kolorów). Przycisk „tryb romans”-niebieski stopniowo zmienia się w czerwony; przycisk „tryb ocean” – zielony stopniowo zmienia się w niebieski; przycisk „tryb ogień” – czerwony stopniowo zmienia się w żółty; przycisk „tryb las” – żółty stopniowo zmienia się w zielony.
	Naciśnij jeden z głównych przycisków kolorów w kole kolorów. Naciśnięcie pobliskiego przycisku spowoduje stopniową zmianę kolorów.
	Regulacja jasności (będzie działać w przypadku trybów kolorów z wyjątkiem trybu nocnego, trybu kolorów losowych i czterech predefiniowanych przycisków zmiany kolorów).

## FI

Valaisinta ei saa käyttää ulkoisella himmentimellä.

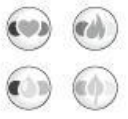





Järjestelmä on aina asetettu lämpimän valkoiselle valolle, kun se kytketään päälle seinäkatkaisijasta.

	Kytke laite päälle painamalla ON-painiketta. Kytke se pois päältä painamalla OFF-painiketta.
	Vaihda järjestelmä ”kodikas lämpöinen”-, ”lämmin valkoinen”- ja ”päivänvalo”-tilaan.
	Kytke yövalotila päälle painamalla painiketta.
	Vaihda satunnaisvärin vaihtotila päälle painamalla painiketta.
	Painamalla yhtä neljästä esiasetetusta värinvaihtopainikkeesta esiohjelmoitu sykli (ainakin 16 värisyklillä) alkaa automaattisesti. Painike ”romanssitila” – sininen vaihtuu asteittain punaiseksi, painike ”valtameritila” – vihreä vaihtuu asteittain siniseksi, painike ”avotulitila” – punainen vaihtuu asteittain keltaiseksi, painike ”metsätila” – keltainen vaihtuu asteittain vihreäksi.
	<i>Paina yhtä pääväripainiketta väriympyrässä. Painamalla vierekkäistä painiketta vaihtaa värin asteittain kyseiseksi väriksi.</i>
	Kirkkauden säätö (toimii väritiloissa, lukuun ottamatta yövaloa, satunnaisväritilaa ja 4 esiasetettua värinvaihtopainiketta).

## CZ

Světlo nesmí být regulováno externím stmívačem.

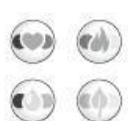





System je při rozsvícení nástěnným vypínačem vždy nastaven na teplé bílé světlo.

	Pro zapnutí přístroje stiskněte tlačítko ON. Pro vypnutí stiskněte tlačítko OFF.
	System můžete přepínat mezi režimy „útulné bílé“, „teplé bílé“ a „denní světlo“.
	Toto tlačítko stiskněte pro zapnutí nočního režimu.
	Toto tlačítko stiskněte pro zapnutí režimu náhodné změny barvy.
	Po stisku jednoho ze čtyř předvoleb pro změnu barev se automaticky spustí naprogramovaný cyklus (s nejméně 16 cykly barev). Tlačítko „Romantický režim“ – modrá se postupně mění v červenou; tlačítko „Režim oceán“ – zelená se postupně mění v modrou; tlačítko „Režim oheň“ – červená se postupně změní ve žlutou; tlačítko „Režim les“ – žlutá se postupně mění v zelenou.
	Stiskněte jedno z tlačítek hlavních barev na barevném kole. Po stisku vedlejšího tlačítka se barva postupně změní.
	Nastavení jasu (bude fungovat u barevných režimů, s výjimkou nočního světla, režimu náhodných barev a 4 tlačítek předvoleb pro změnu barvy).

**RU**

Свет не должен включаться с внешним диммером.







При включении на настенном выключателе система всегда настроена на тепло-белый свет.

	Нажмите кнопку ON, чтобы включить устройство. Нажмите кнопку OFF, чтобы выключить его.
	Переключить систему на «уютный белый», «теплый белый» или «дневной свет».
	Нажмите эту кнопку, чтобы включить режим ночной подсветки.
	Нажмите эту кнопку, чтобы включить случайный режим изменения цвета.
	При нажатии одной из четырех предустановленных кнопок изменения цвета автоматически запускается запрограммированный цикл (с не менее 16 цветовыми циклами). Кнопка «режим романса» - синий постепенно меняется на красный; кнопка «режим океана» - зеленый постепенно меняется на синий; кнопка «режим огня» - красный постепенно меняется на желтый; Кнопка «режим леса» - желтый постепенно меняется на зеленый.
	Нажмите одну из основных цветных кнопок на колесе цветов. При нажатии на соседнюю кнопку цвет будет постепенно изменяться.
	Регулировка яркости (будет работать в цветовых режимах, кроме ночного, случайного цветового режима и 4 предустановленных кнопок изменения цвета).

**RO**







Becul nu trebuie acționat cu un regulator extern al intensității luminoase.

Sistemul se poziționează întotdeauna pe alb cald în momentul în care este pornit de la întrerupătorul de perete.

	Apăsați butonul ON pentru a porni aparatul. Apăsați butonul OFF pentru a-l opri.
	Comută sistemul pe „alb confortabil”, „alb cald” și „lumină naturală”.
	Apăsați acest buton pentru a activa modul de noapte.
	Apăsați acest buton pentru a activa modul de schimbare aleatorie a culorii
	Apăsând unul din cele patru butoane de schimbare a culorilor presetate pornește automat un ciclu pre-programat (cu cel puțin 16 cicluri de culoare). Butonul „Romance mode” - albastrul se schimbă treptat în roșu; Butonul „Ocean mode” - verde se schimbă treptat în albastru; Butonul „Fire mode” - roșu se schimbă treptat în galben; Butonul „Forest mode” - galben se schimbă treptat în verde.
	Apăsați unul dintre butoanele principale de culoare de pe roata culorilor. Prin apăsarea unui buton din apropiere, culoarea se va schimba treptat.
	Reglarea luminozității (funcționează pentru modurile de culoare, cu excepția modului de noapte, a modului de culoare aleator și a celor 4 butoane presetate de schimbare a culorii).

Осветлението да не следва да се управлява от външен димер.







Системата е винаги настроена на топла бяла светлина когато се включва от стенния ключ.

	Натиснете бутона ON за да включите устройството. Натиснете бутона OFF за да го изключите.
	Превключва системата на „топло бяло“, „уютно бяло“ и „дневна светлина“.
	Натиснете бутона за да превключите на нощен режим.
	Натиснете бутона, за да включите режима на промяна на цветовете на случаен принцип.
	Чрез натискане на един от четирите бутона за предварително зададена промяна на цвета, автоматично се стартира предварително програмиран цикъл (с най-малко 16 цветни цикъла). Бутон „романтичен режим“ - синьо постепенно променящо се в червено; Бутон „режим океан“ - зелено постепенно променящо се в синьо; Бутон „режим огън“ - червено постепенно променящо се в жълто; Бутон "горски режим" - жълто постепенно променящо се в зелено.
	Натиснете един от основните цветови бутони на колелото с цветовете. Натискането на съседен бутон постепенно ще промени цвета.
	Регулиране на яркостта (ще работи за цветовете режими, с изключение на нощна светлина, случаен цветови режим и 4-те предварително настроени бутона за промяна на цвета).

## TR

Işık harici bir dimmer ile çalıştırılmamalıdır.

Duvar şalterinde açıldığında sistem her zaman ılık beyaza ayarlanır.







	Cihazı çalıştırmak için ON (AÇMA) düğmesine basın. Cihazı kapatmak için OFF (KAPAMA) düğmesine basın.
	Sistemi "rahat beyaz", "sıcak beyaz" ve "gün ışığı" olarak değiştirin.
	Gece lambası modunu açmak için düğmeye basın.
	Rastgele renk değiştirme modunu açmak için düğmeye basın.
	Ön ayarlı dört renk değiştirme düğmesinden birine bastığınızda önceden programlanmış bir döngü (en az 16 renk döngülü) otomatik olarak başlar. "Romantizm modu" düğmesi – mavi yavaş yavaş kırmızı olarak değişir; "Okyanus modu" düğmesi – yeşil yavaş yavaş mavi olarak değişir; "Ateş modu" düğmesi – kırmızı yavaş yavaş sarı olarak değişir; "Orman modu" düğmesi – sarı yavaş yavaş yeşil olarak değişir.
	Renk tekerleğindeki ana renk düğmelerinden birine basın. Yakındaki bir düğmeye basmak rengi yavaş yavaş değiştirir.
	Parlaklık ayarı (gece lambası, rastgele renk modu ve 4 önayarlı renk değiştirme düğmesi hariç renk modları için çalışır).



**HU**

A fényforrást tilos külső fényerőszabályzóval (dimmer) működtetni.

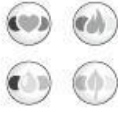





Ha a fali kapcsolóval kapcsolják be, a rendszer mindig melegfehérre van állítva.

	A készülék bekapcsolásához nyomja meg az ON gombot. A kikapcsoláshoz nyomja meg az OFF gombot.
	Állítsa a rendszert "kényelmes fehér", meleg fehér" vagy "nappali fény" értékre.
	Az éjszakai mód bekapcsolásához nyomja meg a gombot.
	A véletlenszerű szín mód bekapcsolásához nyomja meg a gombot.
	A négy előre beállított szín váltása gomb valamelyikét megnyomva egy előre programozott ciklus (legalább 16 színciklussal) indul el automatikusan. A "romantikus mód" gombbal a kék fokozatosan pirosra vált; az "óceán mód" gombbal a zöld fokozatosan kékre vált; a "tűz mód" gombbal a piros fokozatosan sárgára vált; az "erdő mód" gombbal a sárga fokozatosan zöldre vált.
	Nyomja meg a négy főszín gomb valamelyikét a színtárcsán. A közelében lévő gombot megnyomva a szín fokozatosan átvált.
	Fényerő-beállítás (a szín módok esetében működik, kivéve az éjszakai fényt, a véletlenszerű szín módot és a 4 előre beállított szín váltása gombot).

**SE**

Ljuset får inte styras med en extern dimmer.







Systemet är alltid inställt på varmvitt när det tänds med väggströmbrytaren.

	Tryck på ON knappen för att slå på enheten. Tryck på OFF knappen för att stänga av.
	Växla systemet till "mysigt vitt", "varmvitt" och "dagsljus".
	Tryck på knappen för att växla till nattljusläget.
	Tryck på knappen för att växla till läget för slumpmässig färgändring.
	Genom att trycka på en av de fyra förinställda färgändringsknapparna startar automatiskt en förprogrammerad ändringscykel (med minst 16 färgcykler). Knappen "romantiskt läge" – blå som gradvis växlar till rött; Knappen "oceanläge" – grönt som gradvis växlar till blått; Knappen "eldläge" – rött som gradvis växlar till gult; Knappen "skogsläge" – gult som gradvis växlar till grönt.
	Tryck på en av huvudfärgernas knappar på färghjulet. Ett tryck på en närliggande knapp kommer gradvis att ändra färgen.
	Justering av ljusstyrkan (fungerar för färglägena, med undantag för nattljusläget, det slumpmässiga färgläget och de 4 förinställningsknapparna för färgändring).

**HR****Art-Nr.:R671112XX**

Svjetlom ne treba rukovati preko vanjske prigušnice.







Sustav je uvijek postavljen na toplo bijelu boju kada se uključi na zidnom prekidaču.

	Pritisnite gumb UKLJ. kako biste uključili uređaj. Pritisnite gumb ISKLJ. kako biste ga isključili.
	Prebacite sustav na "ugodno bijelo", "toplo bijelo" i "dnevno svjetlo".
	Pritisnite gumb kako biste uključili mod noćne svjetlosti.
	Pritisnite gumb kako biste uključili mod slučajne promjene boje.
	Pritiskom na jedan od četiri gumba za unaprijed postavljenu promjenu boje, započinje automatski programirani ciklus (s najmanje 16 ciklusa boja). Gumb "romantika" - plava se postupno mijenja u crvenu; gumb "ocean" - zelena se postupno mijenja u plavu; gumb "vatra" - crvena se postupno mijenja u žutu; gumb "šuma" - žuta se postupno mijenja u zelenu.
	Pritisnite jedan od gumba za osnovne boje na kotačiću za boje. Pritiskom gumba u blizini promijenit će se boja.
	Podešavanje svjetline (radit će za modove boja, osim za noćnu svjetlost, mod slučajnog odabira boja i 4 gumba za unaprijed postavljenu promjenu boja).







**SL**

Svetilke se ne sme upravljati z zunanjim zatemnilnikom.

Ob vklopu stikala na steni je sistem vedno nastavljen na toplo belo svetlobo.







	Za vklop naprave pritisnite gumb VKLOP (ON). Za izklop pritisnite gumb IZKLOP (OFF).
	Sistem preklopite na "udobno belo", "toplo belo" in "dnevno svetlobo".
	Pritisnite gumb za vklop načina nočne lučke.
	Pritisnite gumb za vklop načina naključnega spreminjanja barve.
	Ko pritisnete enega izmed štirih prednastavljenih gumbov za spreminjanje barve, se samodejno zažene vnaprej sprogramiran cikel (z vsaj 16 barvnimi cikli). Gumb "romantični način" – modra se postopoma spreminja v rdečo; Gumb "oceanski način" – zelenase postopoma spreminja v modro; Gumb "ognjeni način" – rdeča se postopoma spreminja v rumeno; Gumb "gozdni način" – rumena se postopoma spreminja v zeleno.
	Pritisnite enega izmed glavnih barvnih gumbov na barvnem kolesu. S pritiskom na bližnji gumb se bo barva postopoma spreminjala.
	Prilagoditev svetlosti (deluje za barvne načine, razen za nočno lučko, način barve po meri in 4 prednastavljene gumbes za spreminjanje barve).

**SK**  
Svetlo sa nemôže ovládať s využitím externého stmievača.  
Systém je vždy nastavený na teplú bielu, keď sa zapne pomocou nástenného spínača.

	Stlačením tlačidla ON zariadenie zapnete. Stlačením tlačidla OFF ho vypnete.
	Prepnite systém na „príjemnú bielu“, „teplú bielu“ a „denné svetlo“.
	Stlačením tlačidla zapnete režim nočného osvetlenia.
	Stlačením tlačidla zapnete režim náhodnej zmeny farieb.
	Stlačením jedného zo štyroch predvolených tlačidiel zmeny farieb sa automaticky spustí predprogramovaný cyklus (s minimálne 16 farebnými cyklami). Tlačidlo „režim romantiky“ – modrá sa postupne mení na červenú; tlačidlo „režim oceánu“ – zelená sa postupne mení na modrú; tlačidlo „režim ohňa“ – červená sa postupne mení na žltú; tlačidlo „režim lesa“ – žltá sa postupne mení na zelenú.
	Stlačte jedno z hlavných tlačidiel farby na farebnej stupnici. Stlačenie vedľajšieho tlačidla bude postupne meniť farbu.
	Nastavenie jas (bude fungovať pre režimy farby, a to s výnimkou nočného svetla, režimu náhodnej farby a 4 predvolených tlačidiel na zmenu farby).

**PT**







A luz não deve ser utilizada com um regulador de fluxo luminoso externo.  
O sistema está sempre ajustado para um branco quente quando ligado ao interruptor de parede.

	Prima o botão ON para ligar o dispositivo. Prima o botão OFF para desligá-lo.
	Mude o sistema para “acolhedor branco”, “branco quente” e “luz natural”.
	Prima o botão para ligar o modo de luz de presença.
	Prima o botão para ligar o modo de mudança de cor aleatória.
	Ao premir um de quatro botões de mudança de cor predefinidos, um ciclo pré-programado (com pelo menos 16 ciclos de cor) começa automaticamente. Botão “modo romance” – azul muda gradualmente para encarnado; Botão “modo oceano” – verde muda gradualmente para azul; Botão “modo fogo” – vermelho muda gradualmente para amarelo; Botão “modo de floresta” – amarelo muda gradualmente para verde.
	Prima um dos botões de cor principal na roda de cores. Premir um botão próximo irá mudar gradualmente a cor.
	Ajuste de brilho (irá funcionar para os modos de cor, exceto para a luz de presença, o modo de cor aleatória e os 4 botões de mudança de cor pré-definidos).

**BS**

Svjetlom se ne treba rukovati sa eksternim prigušivačem svjetla.

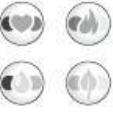





Sistem je uvijek postavljen na toplo bijelo svjetlo kada se upali na zidnom prekidaču.

	Pritisnite tipku UKLJ. da uključite uređaj. Pritisnite tipku ISKLJ. da ga isključite.
	Prebacite sistem na "prijatno bijelo", "toplo bijelo" i "dnevno svjetlo".
	Pritisnite tipku da uključite režim noćne svjetlosti.
	Pritisnite tipku da uključite slučajni odabir promjene boje.
	Pritiskom na jednu od četiri tipke za unaprijed određenu promjenu boje, unaprijed programirani (s najmanje 16 ciklusa boja) počinje automatski. Tipka "romantika" - plava se postupno mijenja u crvenu boju; tipka "ocean" – zelena se postupno mijenja u plavu; tipka "vatra" - crvena se postupno mijenja u žutu; tipka "šuma" - žuta se postupno mijenja u zelenu.
	Pritisnite jednu od tipki za glavne boje na točkiću za boje. Pritiskom na tipku u blizini boja će se postupno promijeniti.
	Podešavanje svjetline (funkcionira kod svih režima boja, osim kod noćne svjetlosti, slučajnog odabira boja i 4 tipke za unaprijed određenu promjenu boje).

**LT**

Išoriniu šviesos reguliatoriumi šviesos įjungti ir išjungti negalima.







Įjungus sienos jungiklį, sistema veiks pagal nustatus gamyklinius parametrus – skleis šiltai baltą šviesą.

	Norėdami įjungti įrenginį, spauskite mygtuką ON. Norėdami išjungti - mygtuką OFF.
	Perjunkite sistemą į „maloniai baltą“, „šiltai baltą“ ar „dienos šviesą“.
	Spauskite šį mygtuką, kad įjungtumėte nakties režimą.
	Spauskite šį mygtuką, kad įjungtumėte atsitiktinių besikeičiančių spalvų režimą.
	Nuspaudus vieną iš šių keturių išankstinio nustatymo spalvų keitimo mygtukų, automatiškai įsijungia iš anksto nustatytas ciklas (mažiausiai 16 spalvų ciklą). Mygtukas „romantiškas režimas“: mėlyna palaipsniui pereina į raudoną; Mygtukas „vandenyno režimas“: žalia palaipsniui pereina į mėlyną; Mygtukas „ugnies režimas“: raudona palaipsniui pereina į geltoną; Mygtukas „miško režimas“: geltona palaipsniui pereina į žalią.
	Paspauskite vieną iš pagrindinių spalvų mygtukų spalvų rate. Paspaudus šalia esantį mygtuką, spalva keisis palaipsniui.
	Ryškumo nustatymas (galimas spalvų režimams, išskyrus nakties režimą, atsitiktinių besikeičiančių spalvų režimą ir 4 išankstinio spalvų nustatymo mygtukus).

**ET**

Valgustit ei tohi kasutada ilma välise valgusregulaatorita.







Süsteem on alati seatud sooja valguse peale, kui sisselülitamiseks kasutatakse seinalülitit.

	Seadme sisselülitamiseks vajutage ON nuppu. Väljalülitamiseks vajutage OFF nuppu.
	Lülitage süsteem „lumivalge“, „soe valge“ ja „päevavalgus“ režiimile.
	Vajutage nuppu, et lülitada öövalguse režiimile.
	Vajutage nuppu, et lülitada juhuslikule värvivahetuse režiimile.
	Vajutades ühte neljast värvivahetuse eelhäälestuse nupust algab automaatselt eelprogrammeeritud tsükkel (vähemalt 16 värvitsükliit). Nupp „romanss“ – sinine värvub järk-järgult punaseks; nupp „ookean“ – roheline värvub järk-järgult siniseks; nupp „tuli“ – punane värvub järk-järgult kollaseks; nupp „mets“ – kollane värvub järk-järgult roheliseks.
	Vajutage ühele põhivärvi nupule värvirattal. Vajutades lähimat nuppu muutub värv järk-järgult.
	Heleduse reguleerimine (toimib värvirežiimidel, välja arvatud öölamp, juhuslik värvirežiim ja 4 värvivahetuse eelhäälestuse nuppu).

**DA**

Lampen må ikke anvendes med en ekstern lysdæmper.

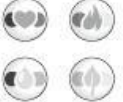





Systemet er altid indstillet til varmt-hvidt lys, når der tændes på stikkontakten på væggen.

	Tryk på ON-knappen for at tænde for enheden. Tryk på OFF-knappen for at slukke den.
	Skift system til "hyggelig hvid", "varm hvid" og "dagslys".
	Tryk på knappen for at skifte til natlystilstand.
	Tryk på knappen for at tænde for tilfældig farveskifttilstand.
	Når der trykkes på en af de fire forindstillede farveskiftknapper, starter en forprogrammeret cyklus (med mindst 16 cyklusser) automatisk. Knappen "romantiktilstand" – blått skifter gradvist til rødt. Knappen "havtilstand" – grønt skifter gradvist til blått. Knappen "brandtilstand" - rødt skifter gradvist til gult. Knappen "skovtilstand" – gult skifter gradvist til grønt.
	Tryk på en af de fire hovedfarveknapper på farvehjulet. Tryk på en nærliggende knap vil gradvist ændre farven.
	Lysstyrkejustering (fungerer i farvetilstandene, bortset fra natlys, tilfældig farvetilstand og de 4 forindstillede farveskiftknapper).

## NO

Lyset må ikke opereres med en ekstern dimmer.







Systemet settes alltid til varmt hvitt når slått på med veggbryteren.

	Trykk på PÅ-knappen for å slå på enheten. Trykk på AV-knappen for å slå den av.
	Systemet kan settes til "koselig hvit", "varm hvit" eller "dagslys".
	Trykk på knappen for å slå på nattlys-modus.
	Trykk på knappen for å bytte til modus med tilfeldig skifte av farge.
	Ved ett trykk på en av de fire knappene for forhåndsinnstilt fargeskifte vil en forhåndsprogrammert syklus (med minst 16 fargesykluser) starte automatisk. Knapp "romantisk modus" – blå endres gradvis til rød; Knapp "hav-modus" – grønn endres gradvis til blå; Knapp "brann-modus" – rød endres gradvis til gul; Knapp "skog-modus" – gul endres gradvis til grønn.
	Trykk på en av de fire fargeknappene på fargehjulet. Trykk på en nærliggende knapp vil gradvis endre fargen.
	Justering av lysstyrke (virker for fargemodusene, unntatt nattlys, tilfeldig farge- modus og de 4 knappene for forhåndsinnstilt fargeskifte).

## LV







Gaismeklis nav paredzēts lietošanai kopā ar ārējo gaismmaini.

Ieslēdzot ar sienas slēdzi, sistēma vienmēr ir iestatīta uz silti balto toni.

	Nospiediet pogu ON, lai ieslēgtu ierīci. Nospiediet pogu OFF, lai to izslēgtu.
	Izvēlieties vienu no sistēmas režīmiem: „patīkami balta gaisma”, „silti balta gaisma” vai „dienasgaisma”.
	Nospiediet šo pogu, lai ieslēgtu nakts apgaismojuma režīmu.
	Nospiediet šo pogu, lai ieslēgtu gadījumišķiršanas krāsu maiņas režīmu.
	Nospiežot vienu no četrām iepriekš iestatītās krāsu maiņas pogām, tiks automātiski uzsākts iepriekš ieprogrammēts cikls (vismaz 16 krāsu toni). „Romantiskā režīma” poga – zilo gaismu pakāpeniski nomainīs sarkanā; „okeāna režīma” poga – zaļo gaismu pakāpeniski nomainīs zilā; „ugunskura režīma” poga – sarkano gaismu pakāpeniski nomainīs dzeltenā; „mežarežīma” poga – dzelteno gaismu pakāpeniski nomainīs zaļā.
	Krāsu aplī varat nospiegt vienu no pamatkrāsu pogām. Nospiežot blakus esošo pogu, krāsa pakāpeniski mainīsies.
	Spilgtuma regulēšana (funkcija aktīva, kad ir ieslēgts jebkurš no režīmiem, izņemot nakts apgaismojumu, gadījumišķiršanas krāsu maiņu un 4 iepriekš iestatītos krāsu maiņas režīmus).







## EL

Μην χρησιμοποιείτε το φωτισμό με εξωτερική συσκευή αυξομείωσης της έντασης. Το σύστημα είναι πάντα ρυθμισμένο σε θερμό λευκό φωτισμό, όταν ενεργοποιείται από τον επιτοίχιο διακόπτη.

	Πατήστε το κουμπί ON για να ενεργοποιήσετε τη συσκευή. Πατήστε το κουμπί OFF για να την απενεργοποιήσετε.
	Αλλάξτε το σύστημα σε "απαλό λευκό", "ζεστό λευκό" και "φως της ημέρας".
	Πατήστε το κουμπί για να ενεργοποιήσετε τη νυχτερινή λειτουργία.
	Πατήστε το κουμπί για να ενεργοποιήσετε τη λειτουργία αλλαγής χρώματος τυχαίας επιλογής.
	Πατώντας ένα από τα τέσσερα προκαθορισμένα κουμπιά αλλαγής χρώματος, ξεκινάει αυτόματα ένας προγραμματισμένος κύκλος (με τουλάχιστον 16 κύκλους χρωμάτων). Κουμπί "ρομαντική λειτουργία" – το μπλε αλλάζει σταδιακά σε κόκκινο. Κουμπί "λειτουργία ωκεανός" – το πράσινο αλλάζει σταδιακά σε μπλε; Κουμπί "λειτουργία φωτιά" – το κόκκινο αλλάζει σταδιακά σε κίτρινο; Κουμπί "λειτουργία δάσους" – το κίτρινο αλλάζει σταδιακά σε πράσινο.
	Πατήστε ένα από τα κύρια κουμπιά χρώματος στο έγχρωμο τροχό. Πατώντας ένα κοντινό κουμπί θα αλλάξει σταδιακά το χρώμα.
	Ρύθμιση φωτεινότητας (θα λειτουργήσει για τις χρωματικές λειτουργίες, εκτός από το νυχτερινή λειτουργία, τη λειτουργία τυχαίου χρώματος και τα 4 προκαθορισμένα κουμπιά αλλαγής χρώματος).

## RS

Ova lampa nije pogodna za upotrebu sa eksternim prigušivačima svetlosti. Kada je zidni prekidač uključen, sistem je uvek podešen na toplo belo.

	Taster za uključanje/isključanje
	Prebacite sistem na udobnu belu, toplu belu i dnevnu svetlost
	Noćno svetlo
	Pritisnite dugme da pokrenete slučajni režim promene boje
	Pritiskom na jedan od četiri unapred podešena tastera za promenu boje automatski se uključuje unapred programirani ciklus sa najmanje 16 boja. Taster za režim romantike - plavo se postepeno menja u crveno; režim okeana - zeleno se postepeno menja u plavo; režim vatre - crveno se postepeno menja u žuto; režim šume - žuto se postepeno menja u zeleno.
	Pritisnite jedan od glavnih tastera za boju na točkiću za boju. Tokom pritiskanja unazad će se boja postepeno menjati.
	Podešavanje osvetljenja (radi za režime boja osim noćnog svetla, slučajni režim boja i 4 unapred podešena tastera za promenu boja).