

**(DE) ACHTUNG!**

Vor Beginn der Montagearbeiten lesen Sie bitte aufmerksam die Sicherheitshinweise!

(EN) WARNING!

Before assembling, please read carefully the safety instructions!

(NL) LET OP!

Lees de veiligheidsinstructies zorgvuldig door voordat u met de montage begint!

(FR) ATTENTION!

Avant le début des travaux de montage, prière de lire attentivement les consignes de sécurité

(IT) ATTENZIONE!

Prima di installare leggere attentamente l'avviso di sicurezza!

(ES) ATENCIÓN!

Antes de comenzar con los trabajos de montaje leer detenidamente los avisos de seguridad!

(PL) UWAGA!

Przed przystąpieniem do prac montażowych uważnie należy przeczytać wskazówki bezpieczeństwa!

(FI) HUOMIO!

Ennen asennustöiden aloittamista pyydämme Teitä lukemaan turvaohjeet huolellisesti!

(CZ) POZOR!

Než začnete provádět montážní práce, přečtete si důkladně bezpečnostní pokyny!

(RU) ВНИМАНИЕ!

До начала монтажных работ внимательно прочтите эти указания по технике безопасности!

(GR) ΠΡΟΣΟΧΗ!

Πριν την διεξαγωγή της συναρμολόγησης διαβάστε προσεκτικά τις υποδείξεις ασφαλείας!

(RO) ATENȚIUNE!

A se citi cu atenție indicațiile privind siguranța, înainte de începerea montării!

(BG) ВНИМАНИЕ!

Преди Да Започнете работите по монтажа прочетете Внимателно упрѢвѢниеТо За безопасност!

(TR) DİKKAT!

Montaja baʼlamadan önce güvenlik talimatnamesini titizlikle okuyunuz!

(HU) FLGYELEM!

A szerelési munkák megkezdése előtt figyelmesen olvassa el a biztonsági útmutatásokat!

(SV) OBS!

Läs säkerhetsanvisningarna noga innan du börjar med monteringsarbetena!

(HR) POZOR!

Prije početka montaže molimo pozorno pročitajte sigurnosne naputke!

(SL) POZOR!

Prosim, da pred zacetkom montaze, zaradi varnosti preberete vas navodila, ki so priložena!

(SK) POZOR!

Pred tým ako začnete robiť montážne práce, prečítajte si dôkladne bezpečnostné pokyny!

(PT) CUIDADO!

Antes de iniciar os trabalhos de montagem por favor leia atentamente os avisos de segurança!

(BA) POZOR!

Prije početka montaže molimo pažljivo pročitajte sigurnosne upute!

(LT) DĖMESIO!

Norėdami saugiai ir teisingai sumontuoti šviestuv vadovaukitės šia instrukcija!

(ET) HOIATUS!

Enne monteerimist lugege ohutusjuhised tähelepanelikult läbi!

(DA) OBS!

Læs sikkerhedsinformationen nøje, før du monterer produktet!

(NO) ADVARSEL!

Les sikkerhetsinformasjonen nøye før du monterer produktet!

(LV) UZMANĪBU!

Pirms montāžas uzmanīgi izlasiet drošības norādījumus!

TRIO Leuchten GmbH
TRIO International GmbH
Dieselstr. 4
D-59823 Arnsberg
www.trio-lighting.com

TRIO International Aydınlatma Tic. Ltd. Sti.
Ferhatpaşa Mahallesi, Üsküdar Caddesi,
Coşkun İş Merkezi No. 42/5,
34888 Ataşehir-İstanbul
www.trio-lighting.com



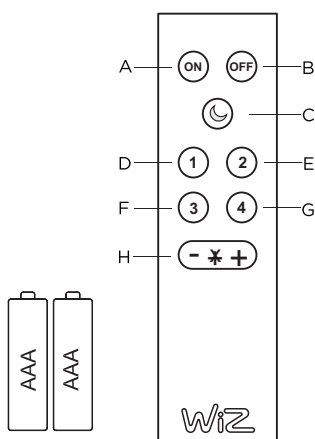
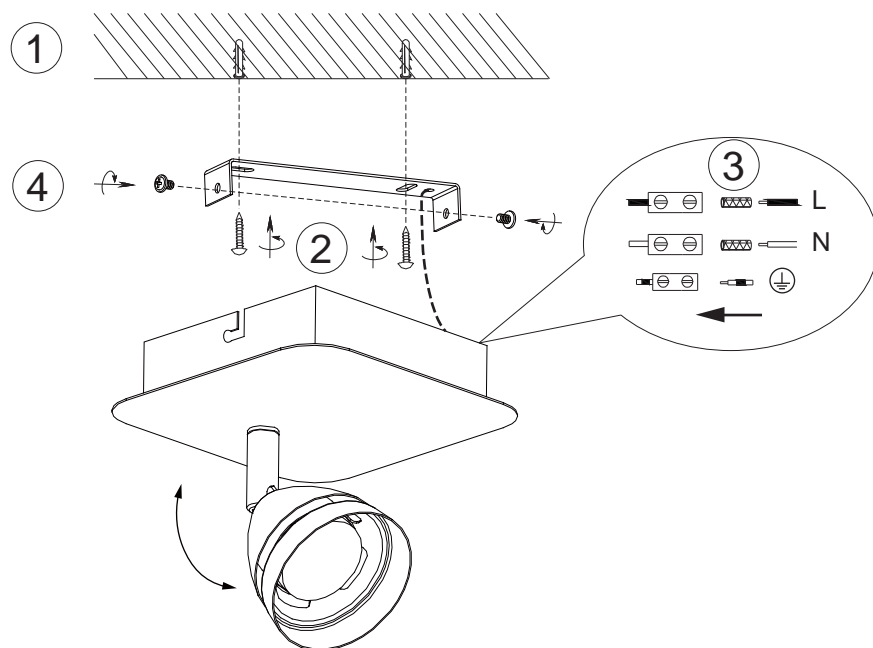



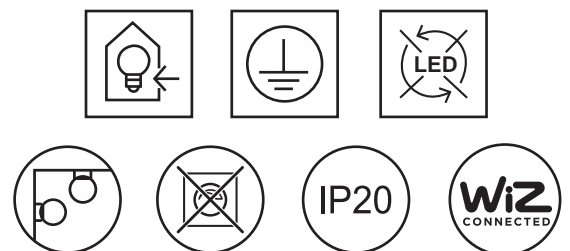



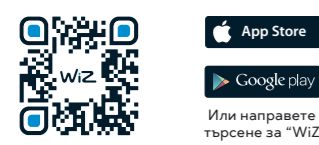
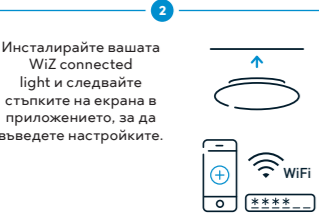

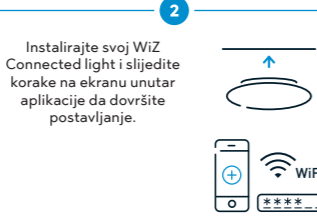
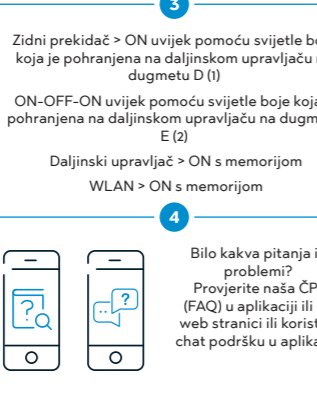
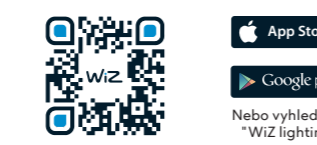
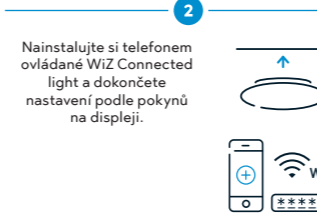
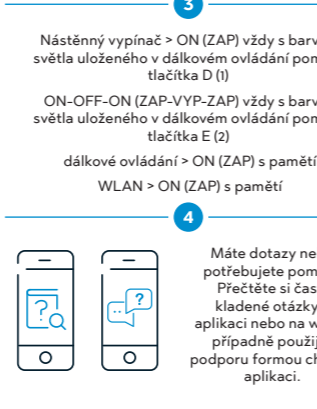
WEEE-Reg. Nr.: 78273666
TRIO Lighting Ibérica s.l.: RAEE 4544
TRIO Lighting Italia s.r.l.: RAEE IT13020000007829
TRIO Lighting Scandinavia Oy: WEEE PIR2005Y354114/2114

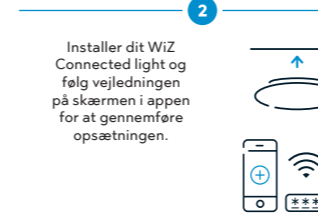
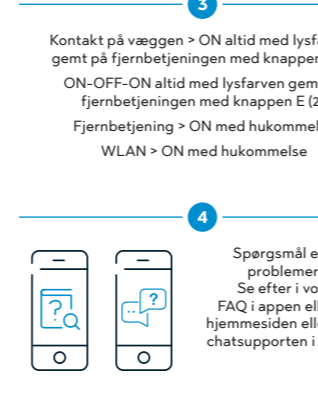

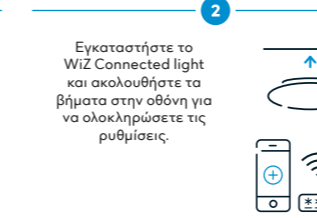
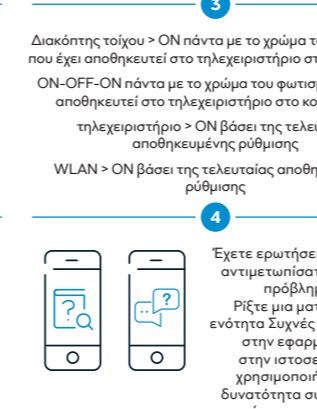

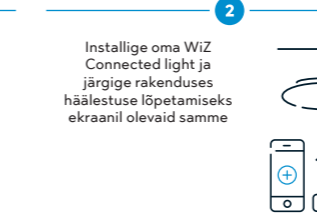

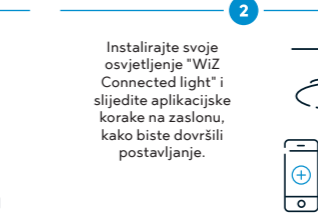
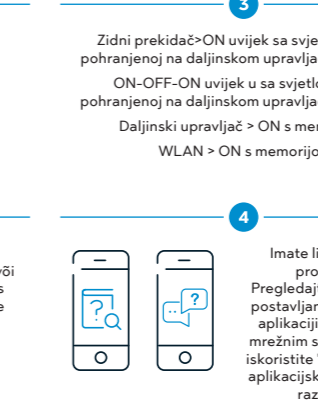

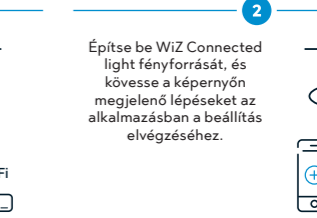
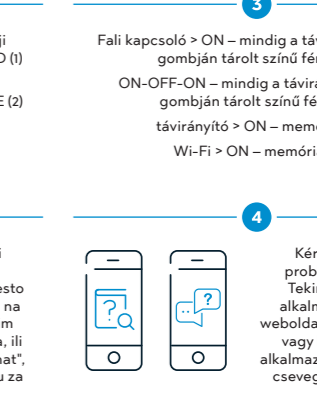

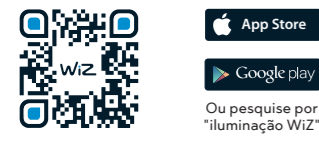
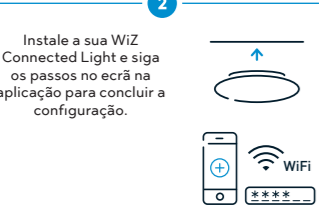
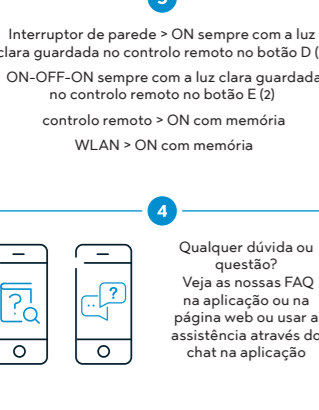

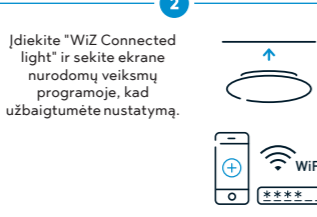
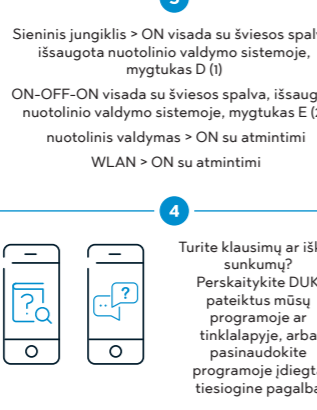

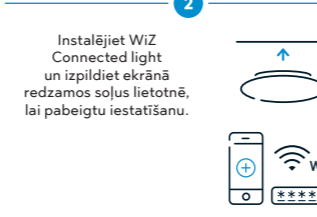
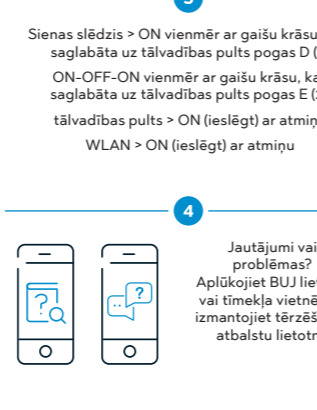

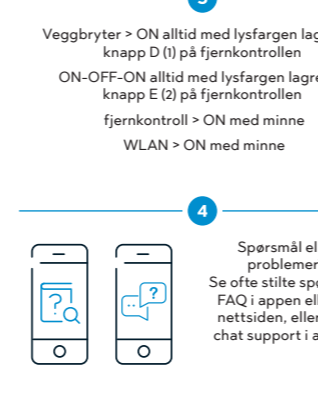
- A. ON
- B. OFF
- C. Night light
- D. Favorite light mode 1
- E. Favorite light mode 2
- F. Favorite light mode 3
- G. Favorite light mode 4
- H. Brightness adjustment

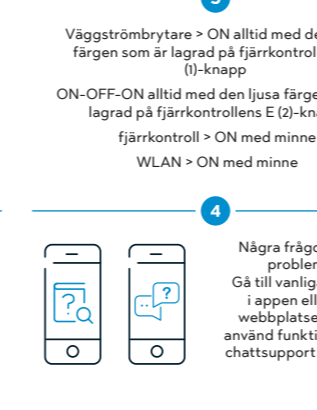

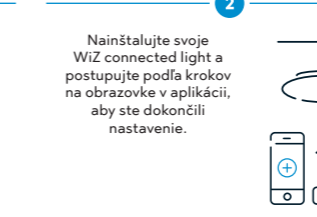
230V~50Hz LED 3W

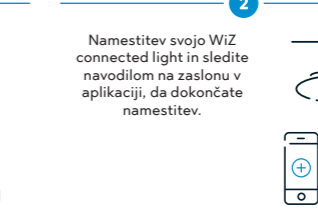
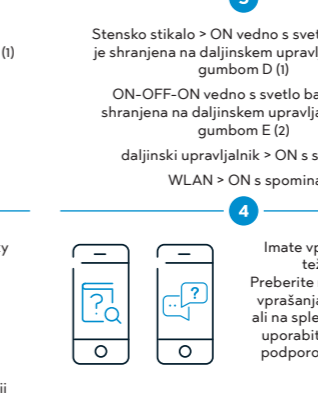
<h2>БЪЛГАРСКИ</h2> <h3>ДОБРЕ ДОШЛИ</h3> <p>1 Изтеглете безплатното приложение Wiz от Google Play или App Store, създайте вашия Wiz Home или се присъединете към такъв.</p>  <p>Или направете търсене за "Wiz"</p> <p>2 Инсталирайте вашата Wiz Connected light и следвайте стъпките на екрана в приложението, за да въведете настройките.</p>  <p>3 Стенен ключ > ON винаги с цвета на светлината запазен в дистанционното управление в бутон D (1) ON-OFF-ON винаги с цвета на светлината запазен в дистанционното управление в бутон E (2) дистанционно управление > ON от паметта WLAN > ON от паметта</p> <p>4 Въпрос или проблем? Прегледайте нашите често задавани въпроси (FAQs) в приложението или на уебсайта или използвайте чата за обслужване в приложението</p> 	<h2>BOSANSKI</h2> <h3>DOBRODOŠLI</h3> <p>1 Preuzmite besplatnu aplikaciju Wiz sa Google Play ili sa Trgovine aplikacijama, kreirajte svoj Wiz Home ili se pridružite postojećem.</p>  <p>Ili pretražite "Wiz lighting"</p> <p>2 Instalirajte svoj Wiz Connected light i slijedite korake na ekranu unutar aplikacije da dovršite postavljanje.</p>  <p>3 Zidni prekidač > ON uvijek pomoću svijetle boje koja je pohranjena na daljinskom upravljaču na dugmetu D (1) ON-OFF-ON uvijek pomoću svijetle boje koja je pohranjena na daljinskom upravljaču na dugmetu E (2) Daljinski upravljač > ON s memorijom WLAN > ON s memorijom</p> <p>4 Bilo kakva pitanja ili problemi? Provjerite naša ČPP (FAQ) u aplikaciji ili na web stranici ili koristite chat podršku u aplikaciji</p> 	<h2>ČEŠTINA</h2> <h3>VÍTEJTE</h3> <p>1 Stáhněte si bezplatnou aplikaci Wiz Prostřednictvím Google Play nebo App Store si vytvořte profil Wiz Home, nebo se připojte k již vytvořenému profilu.</p>  <p>Nebo vyhledejte "Wiz lighting"</p> <p>2 Nainstalujte si telefonem ovládané Wiz Connected light a dokončete nastavení podle pokynů na displeji.</p>  <p>3 Nástěnný vypínač > ON (ZAP) vždy s barvou světla uloženého v dálkovém ovládacím tlačítka D (1) ON-OFF-ON (ZAP-VYP-ZAP) vždy s barvou světla uloženého v dálkovém ovládacím tlačítka E (2) dálkové ovládání > ON (ZAP) s paměť WLAN > ON (ZAP) s paměť</p> <p>4 Máte dotazy nebo potřebujete pomoc? Přechtěte si často kladené otázky v aplikaci nebo na webu, případně použijte podporu formou chatu v aplikaci.</p> 	<h2>DANISH (DANSK)</h2> <h3>VELKOMMEN</h3> <p>1 Download den gratis Wiz-app fra Google Play eller App Store, skab dit eget Wiz Home eller bliv del af et.</p>  <p>Eller søg efter "Wiz lighting"</p> <p>2 Installer dit Wiz Connected light og følg vejledningen på skærmen i appen for at gennemføre opsætningen.</p>  <p>3 Kontakt på væggen > ON altid med lysfarven gemt på fjernbetjeningen med knappen D (1) ON-OFF-ON altid med lysfarven gemt på fjernbetjeningen med knappen E (2) Fjernbetjening > ON med hukommelse WLAN > ON med hukommelse</p> <p>4 Spørgsmål eller problemer? Se efter i vores FAQ i appen eller på hjemmesiden eller brug chatsupporten i appen.</p> 	<h2>ΕΛΛΗΝΙΚΑ</h2> <h3>ΚΑΛΩΣ ΟΡΙΣΑΤΕ</h3> <p>1 Κατεβάστε τη δωρεάν εφαρμογή Wiz Από το Google Play ή το App Store, δημιουργήστε το δικό σας Wiz Home ή συμπεριλάβετε σε ένα άλλο.</p>  <p>Ή εκτελέστε μια αναζήτηση με τους όρους "Wiz lighting"</p> <p>2 Εγκαταστήστε το Wiz Connected light και ακολουθήστε τα βήματα στην οθόνη για να ολοκληρώσετε τις ρυθμίσεις.</p>  <p>3 Διακόπτης τοίχου > ON πάντα με το χρώμα του φωτισμού που έχει αποθηκευτεί στο τηλεχειριστήριο στο κουμπί D (1) ON-OFF-ON πάντα με το χρώμα του φωτισμού που έχει αποθηκευτεί στο τηλεχειριστήριο στο κουμπί E (2) τηλεχειριστήριο > ON βάσει της τελευταίας αποθηκευμένης ρύθμισης WLAN > ON βάσει της τελευταίας αποθηκευμένης ρύθμισης</p> <p>4 Έχετε ερωτήσεις ή μήπως αντιμετωπίσατε κάποιο πρόβλημα; Ρίξτε μια ματιά στην ενότητα Συχνές ερωτήσεις στην ιστοσελίδα ή χρησιμοποιήστε τη δυνατότητα συνομιλίας εντός της εφαρμογής</p> 	<h2>ESTONIAN</h2> <h3>TERE TULEMAST</h3> <p>1 Laadige alla tasuta Wiz'i app Google Play'st või App Store'ist, looge oma Wiz Home või ühinege ühega neist.</p>  <p>Või sisestage otsingusse "Wiz lighting"</p> <p>2 Installige oma Wiz Connected light ja järgige rakenduses häälestuse lõpetamiseks ekraanil olevald samme</p>  <p>3 Seinälüliti > ON alati valguse värviga, mis on salvestatud kaugjuhtimisplüti nupu D (1) alla ON-OFF-ON alati valguse värviga, mis on salvestatud kaugjuhtimisplüti nupu E (2) alla Kaugjuhtimisplüti > ON koos mäluiga WLAN > ON koos mäluiga</p> <p>4 Kas on küsimusi? Vaadake rakenduses või veebilehel meie FAQs (KKK-si), või kasutage äpisisest tuge</p> 	<h2>HRVATSKI</h2> <h3>DOBRO DOŠLI</h3> <p>1 Preuzmite besplatnu "Wiz" aplikaciju iz Google Play ili App Store, kreirajte vaš osobni "Wiz Home" ili se pridružite jednom od postojećih.</p>  <p>Ili potražite osvjetljenje "Wiz lighting"</p> <p>2 Instalirajte svoje osvjetljenje "Wiz Connected light" i slijedite aplikacijske korake na zaslonu, kako biste dovršili postavljanje.</p>  <p>3 Zidni prekidač > ON uvijek sa svjetlom u boji pohranjenoj na daljinskom upravljaču, tipka D (1) ON-OFF-ON uvijek u sa svjetlom u boji pohranjenoj na daljinskom upravljaču, tipka E (2) Daljinski upravljač > ON s memorijom WLAN > ON s memorijom</p> <p>4 Imate li pitanje ili problem? Pregledajte FAQ (često postavljana pitanja) na aplikaciji ili na našim mrežnim stranicama, ili iskoristite "in-app chat", aplikacijsku podršku za razgovor</p> 	<h2>HUNGARIAN</h2> <h3>ÜDVÖZÖLJÜK!</h3> <p>1 Töltse le az ingyenes Wiz alkalmazást a Google Play Áruházból vagy az App Store-ból, hozza létre saját Wiz Home otthonát, vagy csatlakozzon egyhez.</p>  <p>Vagy keressen rá a "Wiz lighting"-re</p> <p>2 Építse be Wiz Connected light fényforrását, és kövesse a képernyőn megjelenő lépéseket az alkalmazásban a beállítás elvégzéséhez.</p>  <p>3 Fali kapcsoló > ON – mindig a távirányító "D" (1) gombján tárolt színű fényfel. ON-OFF-ON – mindig a távirányító "E" (2) gombján tárolt színű fényfel. Távirányítók > ON – memóriával Wi-Fi > ON – memóriával</p> <p>4 Kérdése vagy problémája van? Tekintse meg az alkalmazás vagy a weboldal GYIK részét, vagy használja az alkalmazásban elérhető csupportárgatást</p> 
------------------------------------------------------------------------------------------------------------------------------------------------------------------------------------------------------------------------------------------------------------------------------------------------------------------------------------------------------------------------------------------------------------------------------------------------------------------------------------------------------------------------------------------------------------------------------------------------------------------------------------------------------------------------------------------------------------------------------------------------------------------------------------------------------------------------------------------------------------------------------------------------------------------------------------------------------------------------------------------------------------------------------------------------------------------------------------	--------------------------------------------------------------------------------------------------------------------------------------------------------------------------------------------------------------------------------------------------------------------------------------------------------------------------------------------------------------------------------------------------------------------------------------------------------------------------------------------------------------------------------------------------------------------------------------------------------------------------------------------------------------------------------------------------------------------------------------------------------------------------------------------------------------------------------------------------------------------------------------------------------------------------------------------------------------------------------------------------------------------------------------------------------------------------------------------	-----------------------------------------------------------------------------------------------------------------------------------------------------------------------------------------------------------------------------------------------------------------------------------------------------------------------------------------------------------------------------------------------------------------------------------------------------------------------------------------------------------------------------------------------------------------------------------------------------------------------------------------------------------------------------------------------------------------------------------------------------------------------------------------------------------------------------------------------------------------------------------------------------------------------------------------------------------------------------------------------------------------------------------------------------------------------------------------------	-------------------------------------------------------------------------------------------------------------------------------------------------------------------------------------------------------------------------------------------------------------------------------------------------------------------------------------------------------------------------------------------------------------------------------------------------------------------------------------------------------------------------------------------------------------------------------------------------------------------------------------------------------------------------------------------------------------------------------------------------------------------------------------------------------------------------------------------------------------------------------------------------------------------------------------------------------------------------------------------------	--------------------------------------------------------------------------------------------------------------------------------------------------------------------------------------------------------------------------------------------------------------------------------------------------------------------------------------------------------------------------------------------------------------------------------------------------------------------------------------------------------------------------------------------------------------------------------------------------------------------------------------------------------------------------------------------------------------------------------------------------------------------------------------------------------------------------------------------------------------------------------------------------------------------------------------------------------------------------------------------------------------------------------------------------------------------------------------------------------------------------------------------------------------------------------------------------------------------------------------	----------------------------------------------------------------------------------------------------------------------------------------------------------------------------------------------------------------------------------------------------------------------------------------------------------------------------------------------------------------------------------------------------------------------------------------------------------------------------------------------------------------------------------------------------------------------------------------------------------------------------------------------------------------------------------------------------------------------------------------------------------------------------------------------------------------------------------------------------------------------------------------------------------------------------------------------------------------------------------------------------------------	----------------------------------------------------------------------------------------------------------------------------------------------------------------------------------------------------------------------------------------------------------------------------------------------------------------------------------------------------------------------------------------------------------------------------------------------------------------------------------------------------------------------------------------------------------------------------------------------------------------------------------------------------------------------------------------------------------------------------------------------------------------------------------------------------------------------------------------------------------------------------------------------------------------------------------------------------------------------------------------------------------------------------------------------------------------------------------------------------------------------------------------------------------------------	------------------------------------------------------------------------------------------------------------------------------------------------------------------------------------------------------------------------------------------------------------------------------------------------------------------------------------------------------------------------------------------------------------------------------------------------------------------------------------------------------------------------------------------------------------------------------------------------------------------------------------------------------------------------------------------------------------------------------------------------------------------------------------------------------------------------------------------------------------------------------------------------------------------------------------------------------------------------------------------------------------------------------------------------------------------------------------------

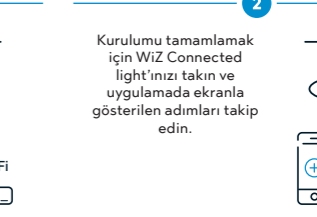
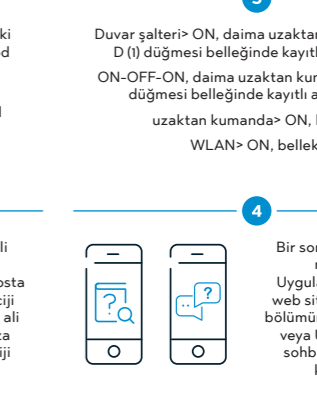
<h2>INGLÉS</h2> <h3>BEM-VINDO</h3> <p>1 Descarregue a aplicação gratuita Wiz Do Google Play ou na App Store, crie a sua Wiz Home ou junte-se a uma.</p>  <p>Ou pesquise por "iluminação Wiz"</p> <p>2 Instale a sua Wiz Connected Light e siga os passos no ecrã na aplicação para concluir a configuração.</p>  <p>3 Interruptor de parede > ON sempre com a luz clara guardada no controlo remoto no botão D (1) ON-OFF-ON sempre com a luz clara guardada no controlo remoto no botão E (2) controlo remoto > ON com memória WLAN > ON com memória</p> <p>4 Qualquer dúvida ou questão? Veja as nossas FAQ na aplicação ou na página web ou usar a assistência através do chat na aplicação</p> 	<h2>LIETUVIŠKAI</h2> <h3>SVEIKI</h3> <p>1 Parsisiųti nemokamą "Wiz" programą "Google Play" arba "App Store" sukurkite savo "Wiz Home" vietni vai prisienkite prie jau esamų.</p>  <p>Arba susiraskite "Wiz lighting"</p> <p>2 Įdiekite "Wiz Connected light" ir sekite ekrane nurodomų veiksmų programoje, kad užbaigtumėte nustatymą.</p>  <p>3 Sieninis jungiklis > ON visada su šviesos spalva, išsaugota nuotolinio valdymo sistemoje, mygtukas D (1) ON-OFF-ON visada su šviesos spalva, išsaugota nuotolinio valdymo sistemoje, mygtukas E (2) nuotolinis valdymas > ON su atmintimi WLAN > ON su atmintimi</p> <p>4 Turite klausimų ar iškilio sunkumų? Perskaitykite DUK, pateiktus mūsų programoje ar tinklalapyje, arba pasinaudokite programoje įdiegta tiesiogine pagalba</p> 	<h2>LATVIEŠU</h2> <h3>LAIPIŅI LŪDZAM!</h3> <p>1 Lejupielādējiet bezmaksas Wiz lietotni no Google Play vai App Store un izveidojiet savu Wiz Home vietni vai pievienojieties jau esošai.</p>  <p>Vai meklējiet "Wiz lighting"</p> <p>2 Instalējiet Wiz Connected light un izpildiet ekrānā redzamos soļus lietotnē, lai pabeigtu iestatīšanu.</p>  <p>3 Siens slēdzis > ON vienmēr ar gaišu krāsu, kas saglabāta uz tālvadības pults pogas D (1) ON-OFF-ON vienmēr ar gaišu krāsu, kas saglabāta uz tālvadības pults pogas E (2) tālvadības pults > ON (ieslēgt) ar atmiņu WLAN > ON (ieslēgt) ar atmiņu</p> <p>4 Jautājumi vai problēmas? Aplūkojiet BUJ lietotnē vai tīmekļa vietnē, vai izmantojiet tēršanās atbalstu lietotnē</p> 	<h2>NORSK</h2> <h3>VELKOMMEN</h3> <p>1 Last ned Wiz app gratis fra Google Play eller App Store, skap ditt Wiz Home eller koble til ett.</p>  <p>Eller søk etter "Wiz lighting"</p> <p>2 Installer Wiz Connected light og følg instruksjonene på skjermen i appen for å fullføre oppsettet.</p>  <p>3 Veggbryter > ON alltid med lysfargen lagret på knapp D (1) på fjernkontrollen ON-OFF-ON alltid med lysfargen lagret på knapp E (2) på fjernkontrollen fjernkontroll > ON med minne WLAN > ON med minne</p> <p>4 Spørgsmål eller problemer? Se ofte stilte spørsmål/FAQ i appen eller på nettsiden, eller bruk chat support i appen.</p> 	<h2>SVENSKA</h2> <h3>VÄLKOMMEN</h3> <p>1 Ladda ned den kostnadsfria Wiz-appen från Google Play eller App Store, skapa din Wiz Home eller anslut till en.</p>  <p>Eller sök efter "Wiz lighting"</p> <p>2 Installera din Wiz Connected light och följ stegen på skärmen i appen för att slutföra installationen.</p>  <p>3 Väggströmbrytare > ON alltid med den ljusa färgen som är lagrad på fjärrkontrollens D (1)-knapp ON-OFF-ON alltid med den ljusa färgen som är lagrad på fjärrkontrollens E (2)-knapp fjärrkontroll > ON med minne WLAN > ON med minne</p> <p>4 Några frågor eller problem? Gå till vanliga frågor i appen eller på webbplatsen eller använd funktionen för chatsupport i appen.</p> 	<h2>SLOVENSKY</h2> <h3>VITAJTE</h3> <p>1 Prevezmite si brezplačno aplikacijo Wiz z obhodu Google Play alebo App Store, vytvorite si Domácnost Wiz alebo sa k nejakej pridajte.</p>  <p>Alebo vyhľadajte "Wiz lighting"</p> <p>2 Nainštalujte svoje Wiz connected light a postupujte podľa krokov na obrazovke v aplikácii, aby ste dokončili nastavenie.</p>  <p>3 Nástěnný spínač > ON vždy s farbou svetla uloženou v diaľkovom ovládaní pod tlačidlom D (1) ON-OFF-ON vždy s farbou svetla uloženou v diaľkovom ovládaní pod tlačidlom E (2) diaľkové ovládanie > ON s pamäťou WLAN > ON s pamäťou</p> <p>4 Máte akékoľvek otázky alebo problémy? Pozrite si naše Najčastejšie otázky v aplikácii alebo na webovej stránke, prípadne použite podporu cez konverzáciu v aplikácii</p> 	<h2>SLOVENŠČINA</h2> <h3>DOBRODOŠLI</h3> <p>1 Prenesite brezplačno Wiz aplikacijo Prek trgovine Google Play ali App Store, ustvarite svoj Wiz Home ali se pridružite drugim.</p>  <p>Ali v iskalnik vnesite "Wiz lighting"</p> <p>2 Namestitev svoje Wiz connected light in sledite navodilom na zaslonu v aplikaciji, da dokončate namestitev.</p>  <p>3 Stensko stikalo > ON vedno s svetlo barvo, ki je shranjena na daljinskem upravljalniku pod gumbom D (1) ON-OFF-ON vedno s svetlo barvo, ki je shranjena na daljinskem upravljalniku pod gumbom E (2) daljinski upravljalnik > ON s spomina WLAN > ON s spomina</p> <p>4 Imate vprašanja ali težave? Preberite naša Pogosta vprašanja v aplikaciji ali na spletni strani, ali uporabite klepet za podporo v aplikaciji</p> 	<h2>TURKISH</h2> <h3>HOŞ GELDİNİZ</h3> <p>1 Ücretsiz Wiz uygulamasını indirin Google Play'den veya App Store'dan Wiz Home'unuzu oluşturun veya birine katılın.</p>  <p>Ya da "Wiz lighting" araması yapın</p> <p>2 Kurulumu tamamlamak için Wiz Connected light'ınızı takın ve uygulamada ekranla gösterilen adımları takip edin.</p>  <p>3 Duvar şalteri > ON, daima uzaktan kumandadaki D (1) düğmesi belleğinde kayıtlı açık renkle ON-OFF-ON, daima uzaktan kumandadaki E (2) düğmesi belleğinde kayıtlı açık renkle uzaktan kumanda > ON, bellekli WLAN > ON, bellekli</p> <p>4 Bir soru veya sorun mu var? Uygulamadaki veya web sitesindeki SSS bölümümüze inceleyin veya Uygulama içi sohbet desteğini kullanın</p> 
---------------------------------------------------------------------------------------------------------------------------------------------------------------------------------------------------------------------------------------------------------------------------------------------------------------------------------------------------------------------------------------------------------------------------------------------------------------------------------------------------------------------------------------------------------------------------------------------------------------------------------------------------------------------------------------------------------------------------------------------------------------------------------------------------------------------------------------------------------------------------------------------------------------------------------------------------------------------------------------------------------------	------------------------------------------------------------------------------------------------------------------------------------------------------------------------------------------------------------------------------------------------------------------------------------------------------------------------------------------------------------------------------------------------------------------------------------------------------------------------------------------------------------------------------------------------------------------------------------------------------------------------------------------------------------------------------------------------------------------------------------------------------------------------------------------------------------------------------------------------------------------------------------------------------------------------------------------------------------------------------------------------------------------------------------------------------------------------------------------------------	----------------------------------------------------------------------------------------------------------------------------------------------------------------------------------------------------------------------------------------------------------------------------------------------------------------------------------------------------------------------------------------------------------------------------------------------------------------------------------------------------------------------------------------------------------------------------------------------------------------------------------------------------------------------------------------------------------------------------------------------------------------------------------------------------------------------------------------------------------------------------------------------------------------------------------------------------------------------------------------------------------------------------------------------------	---------------------------------------------------------------------------------------------------------------------------------------------------------------------------------------------------------------------------------------------------------------------------------------------------------------------------------------------------------------------------------------------------------------------------------------------------------------------------------------------------------------------------------------------------------------------------------------------------------------------------------------------------------------------------------------------------------------------------------------------------------------------------------------------------------------------------------------------------------------------------------------------------------------------------------------------------------------	-------------------------------------------------------------------------------------------------------------------------------------------------------------------------------------------------------------------------------------------------------------------------------------------------------------------------------------------------------------------------------------------------------------------------------------------------------------------------------------------------------------------------------------------------------------------------------------------------------------------------------------------------------------------------------------------------------------------------------------------------------------------------------------------------------------------------------------------------------------------------------------------------------------------------------------------------------------------------------------------------------------------------------	----------------------------------------------------------------------------------------------------------------------------------------------------------------------------------------------------------------------------------------------------------------------------------------------------------------------------------------------------------------------------------------------------------------------------------------------------------------------------------------------------------------------------------------------------------------------------------------------------------------------------------------------------------------------------------------------------------------------------------------------------------------------------------------------------------------------------------------------------------------------------------------------------------------------------------------------------------------------------------------------------------------------------------------------------------------------------------------------------------	------------------------------------------------------------------------------------------------------------------------------------------------------------------------------------------------------------------------------------------------------------------------------------------------------------------------------------------------------------------------------------------------------------------------------------------------------------------------------------------------------------------------------------------------------------------------------------------------------------------------------------------------------------------------------------------------------------------------------------------------------------------------------------------------------------------------------------------------------------------------------------------------------------------------------------------------------------------------------------------------------------------------------------------------------------------------------------------------------	----------------------------------------------------------------------------------------------------------------------------------------------------------------------------------------------------------------------------------------------------------------------------------------------------------------------------------------------------------------------------------------------------------------------------------------------------------------------------------------------------------------------------------------------------------------------------------------------------------------------------------------------------------------------------------------------------------------------------------------------------------------------------------------------------------------------------------------------------------------------------------------------------------------------------------------------------------------------------------------------------------------------------------------------

Let's get started



TRIO
LIGHTING FOR YOU

COULDN'T BE EASIER

Pair & share. Instantly.



- Instant pairing
- No hub required
- Multi-user
- Secured cloud
- Multi-location
- Control anywhere



THE WIZ DNA

WIZ brings total flexibility with 64,000 shades of white and dimming. It's the very minimum of what should be expected for the 21st century.

64,000 WHITES

Preset light modes



16 Million COLORS

Dynamic light modes



WIZ lighting experts have designed dynamic color modes that completely outshine the rest of the industry. Like great music tracks, perfectly synchronized and randomized, our modes make any room glow with stunning lighting ambiances.

ENGLISH

WELCOME

1

Download the free WIZ app from Google Play or the App Store, create your WIZ Home or join one.

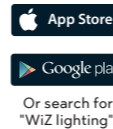

2

Install your WIZ Connected light and follow the on-screen steps in the app to complete set up.



3

Wall switch > always with the light colour stored on the remote control on button D (1)
ON-OFF-ON always with the light colour stored on the remote control on button E (2)
remote control > ON with memory
WLAN > ON with memory



Any question or issue? Check out our FAQs in the app or on the website or use the in-app chat support

FRANCAIS

BIENVENUE

1

Téléchargez l'application gratuite WIZ depuis Google Play ou l'App Store, créez votre maison WIZ ou rejoignez-en une.

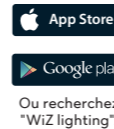

2

Installez votre lampe connectée WIZ et suivez les différentes étapes dans l'application pour effectuer la configuration



3

Interrupteur mural > ON toujours avec la couleur de la lumière mémorisée sur le bouton D de la télécommande (1)
ON-OFF-ON toujours avec la couleur de la lumière mémorisée sur le bouton E de la télécommande (2)
Télécommande > ON avec paramètres mémorisés
WLAN > ON avec paramètres mémorisés



Une question ou un problème? Consultez nos FAQs dans l'application ou sur le site Web ou utilisez l'assistance par chat de l'application

NEDERLANDS

WELKOM

1

Download de gratis WIZ-app vanaf Google Play of de App Store, creëer uw WIZ Home of treed er tot een toe.

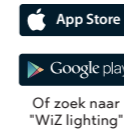

2

Installeer uw WIZ connected light en volg de stappen op het scherm in de app om de installatie te voltooien.



3

Wandschakelaar > altijd ON met de lichtkleur opgeslagen op de afstandsbediening op toets D (1)
Altijd ON-OFF-ON met de lichtkleur opgeslagen op de afstandsbediening op toets E (2)
afstandsbediening > ON met herinnering
WLAN > ON met herinnering



Vragen of problemen? Bekijk de FAQ's in de app of op de website of maak gebruik van de chatsupport in de app

ROMÂNĂ

BINE AȚI VENIT

1

Descărcați aplicația gratuită WIZ Din Google Play sau App Store, creați-vă propriul WIZ Home sau alăturați-vă unuia.

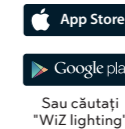

2

Instalați-vă WIZ Connected light și urmați pașii de pe ecran din aplicație pentru a finaliza configurarea.



3

Înterupător de perete > ON întotdeauna cu culoarea luminii memorată pe butonul D (1) al telecomenzii
ON-OFF-ON întotdeauna cu culoarea memorată pe butonul E (2) al telecomenzii
telecomandă > ON cu setarea memorată
WLAN > ON cu setarea memorată



Aveți întrebări sau probleme? Citiți secțiunea FAQ (Întrebări și răspunsuri) din aplicație sau de pe site sau folosiți chat-ul pentru asistență din aplicație

POLSKI

WITAMY

1

Pobierz bezpłatną aplikację WIZ Z Google Play lub sklepu App, stwórz własny WIZ Home lub przyłącz się do już istniejącego.

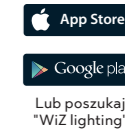

2

Zainstaluj swoje WIZ Connect light i postępuj zgodnie z krokami na ekranie w aplikacji, aby dokończyć ustawianie.



3

Przełącznik ścienny > ON zawsze jasny kolor na pilocie na przycisku D (1)
ON-OFF-ON zawsze jasny kolor na pilocie na przycisku E (2)
pilot > ON z pamięcią
WLAN > ON z pamięcią



Masz jakieś pytania lub problemy? Sprawdź nasze PIO w aplikacji lub zajrzyj na naszą stronę lub skorzystaj ze wsparcia na czacie

DEUTSCH

WILLKOMMEN

1

Laden Sie die kostenlose WIZ-App aus Google Play oder dem App Store herunter, erstellen Sie Ihr WIZ Home oder treten Sie einem bei.

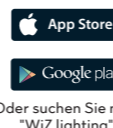

2

Installieren Sie Ihre WIZ-Connected-Leuchte und befolgen Sie zum Abschließen der Einrichtung die Bildschirmanweisungen in der App.



3

Wandschalter > ON immer mit der Lichtfarbe, die auf der Fernbedienung auf Taste D (1) gespeichert ist
ON-OFF-ON immer mit der Lichtfarbe, die auf der Fernbedienung auf Taste E (2) gespeichert ist
Fernbedienung > ON mit Memoryfunktion
WLAN > ON mit Memoryfunktion



Sie haben Fragen oder Probleme? Prüfen Sie unsere häufig gestellten Fragen in der App oder auf der Webseite oder Nutzen Sie den Chat-Support in der App

ESPAÑOL

BIENVENIDO

1

Descargue gratuitamente la aplicación WIZ en Google Play o en App Store y cree su hogar WIZ o únase a uno.



2

Instale su luz WIZ Connected y siga los pasos que aparecen en la pantalla de la aplicación para completar la configuración.



3

Interruptor de pared > ON siempre con el color de la luz guardado en el mando a distancia en el botón D (1)
ON-OFF-ON siempre con el color de la luz guardado en el mando a distancia en el botón E (2)
Mando a distancia > ON con memoria
WLAN > ON con memoria



¿Alguna pregunta o problema? Consulte nuestras preguntas frecuentes en la aplicación o en nuestro sitio web o bien utilice nuestro chat para soporte técnico en nuestra aplicación

ITALIANO

BENVENUTO

1

Scaricare l'app WIZ gratuita da Google Play o App Store per creare WIZ Home o unirsi a uno.

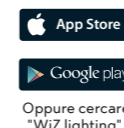

2

Installare WIZ Connected Luce e seguire le procedure su schermo nell'app per completare la configurazione.



3

Interruttore posto sul muro > ON sempre con il colore della luce memorizzato sul telecomando al pulsante D (1)
ON-OFF-ON sempre con il colore della luce memorizzato sul telecomando al pulsante E (2)
telecomando > ON con le impostazioni in memoria
WLAN > ON con le impostazioni in memoria



Domande o problemi? Controllare le FAQs nell'app o sul sito web oppure Utilizzare l'assistenza via chat nell'app

FINNISH

TERVETULOA

1

Lataa ilmainen WIZ-sovellus Google Playstä tai App Storesta, ja luo oma WIZ Home, tai liity mukaan sellaiseen.

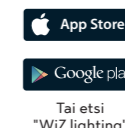

2

Asenna WIZ Connected light -valaisimesi, ja noudata sovelluksen näytön esittämiä vaiheita tehäksesi asetukset valmiiksi.



3

Seinäkatkaisin > ON aina sillä valon värillä, joka on tallennettu kaukosäätimeen painikkeella D (1)
ON-OFF-ON aina sillä valon värillä, joka on tallennettu kaukosäätimeen painikkeella E (2)
kaukosäädin > ON muistiin tallennetulla värillä
WLAN > ON muistiin tallennetulla värillä



Kysyttävää tai ongelmia? Katso UKK:me sovelluksesta tai verkkosivuiltamme, tai käytä sovelluksen sisäistä tukea.

РУССКИЙ

ДОБРО ПОЖАЛОВАТЬ

1

Загрузите бесплатное приложение WIZ в Google Play или в App Store, создайте свой WIZ Home или присоединитесь к нему.

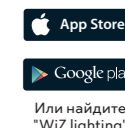

2

Установите WIZ Connected light и следуйте инструкциям на экране в приложении, чтобы завершить настройку.



3

Настенный выключатель > ON всегда со светлым цветом, на пульте ДУ на кнопке D (1)
ON-OFF-ON всегда со светлым цветом на пульте ДУ на кнопке E (2)
Пульт ДУ > ON настройка из памяти
WLAN > ON настройка из памяти



Ознакомьтесь с нашими часто задаваемыми вопросами в приложении или на веб-сайте или воспользуйтесь чатом поддержки в приложении.

THE COLLECTION



E27
987-88



E14
983-88



GU10
956-88

STREAMLINE YOUR LIFE

WIZ already has 60+ popular IFTTT applets available on <https://ifttt.com/wiz>

Enjoy Amazon Alexa with smart home skill. You can also use Google Assistant on Google Home or your smartphone.



Turn on the light when my security camera detects motion

Change the light to cool white when it gets hot

Change the light to bright red in case of a carbon monoxide emergency

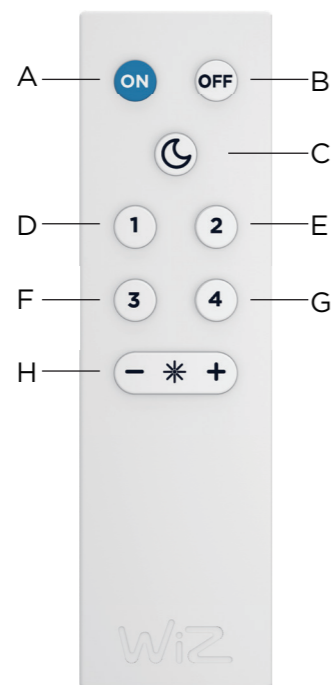

ZIS03587

1. Botones de WiZmote

- A. ON
- B. OFF
- C. Luz nocturna
- D. Modo de luz favorito 1
- E. Modo de luz favorito 2
- F. Modo de luz favorito 3
- G. Modo de luz favorito 4
- H. Ajuste del brillo

2. Modos de luz favoritos predeterminados

En el sistema WiZ, cada lámpara pertenece a una sala, que se selecciona mientras se configura la lámpara en nuestra aplicación. Hay disponibles varios tipos de sala para seleccionar (por ejemplo, "Cocina" o "Dormitorio"). Para cada tipo de sala dado, WiZ proporciona un conjunto de 4 modos de luz favoritos, adoptados de forma predeterminada por todas las lámparas situadas en la sala. Puede cambiar rápidamente entre los 4 modos con los botones ①, ②, ③ y ④ de su WiZmote.

3. Modos de luz favoritos personalizados

La aplicación WiZ también le permite editar sus modos de luz favoritos en sus salas, asignando así los modos de luz que elija a los botones ①, ②, ③ y ④. Puede obtener más información sobre cómo usar la aplicación WiZ en wiz.world.

- 4. Interruptor de pared > ON siempre con el color de la luz guardado en el mando a distancia en el botón D (1)
ON-OFF-ON siempre con el color de la luz guardado en el mando a distancia en el botón E (2)
Mando a distancia > ON con memoria
WLAN > ON con memoria

Se debe deshacer de este producto y de las pilas en un punto de recolección designado para desperdicios eléctricos y electrónicos. Para obtener más información, póngase en contacto con la oficina local de la ciudad o con la tienda donde adquirió el producto.

1. WiZmote-knoppen

- A. Aan
- B. uit
- C. Nachtlampje Favoriete
- D. lichtmodus 1 Favoriete
- E. lichtmodus 2 Favoriete
- F. lichtmodus 3 Favoriete
- G. lichtmodus 4 Aanpassing
- H. helderheid

2. Standaard favoriete lichtmodi

In het WiZ-systeem hoort elke lamp bij een kamer die u selecteert tijdens het instellen van de lamp in onze app. Er zijn verschillende kamertypes beschikbaar waaruit u kunt kiezen (bijv. "keuken" of "slaapkamer"). Voor elk gegeven kamertype biedt WiZ een set van 4 favoriete lichtmodi, die standaard worden gebruikt door alle lampen die in de kamer zijn geplaatst. U kunt snel schakelen tussen de 4 modi met de knoppen ①, ②, ③ en ④ op uw WiZmote.

3. Aangepaste favoriete lichtmodi

Met de WiZ-app kunt u ook uw favoriete lichtmodi bewerken in uw kamers en zo de lichtmodi van uw keuze toewijzen aan de knoppen ①, ②, ③ en ④. Leer meer over het gebruik van de WiZ-app op wiz.world.

- 4. Wandschakelaar > altijd ON met de lichtkleur opgeslagen op de afstandsbediening op toets D (1)
Altijd ON-OFF-ON met de lichtkleur opgeslagen op de afstandsbediening op toets E (2)
afstandsbediening > ON met herinnering
WLAN > ON met herinnering

Dit product en deze batterijen moet worden verwijderd bij een aangewezen inzamelpunt voor afgedankte elektrische en elektronische apparatuur. Neem contact op met uw lokale instanties of de winkel waar u het product hebt aangeschaft.

1. WiZmote buttons

- A. ON
- B. OFF
- C. Night light
- D. Favorite light mode 1
- E. Favorite light mode 2
- F. Favorite light mode 3
- G. Favorite light mode 4
- H. Brightness adjustment

2. Default favorite light modes

In the WiZ system, every lamp belongs to a room, which you select while setting up the lamp in our app. Several room types are available for you to choose from (e.g. "Kitchen" or "Bedroom"). For each given room type, WiZ provides a set of 4 favorite light modes, adopted by default by all lamps placed in the room. You can quickly switch between the 4 modes with the ①, ②, ③ and ④ buttons on your WiZmote.

3. Customized favorite light modes

The WiZ app also allows you to edit your favorite light modes in your rooms, thus assigning light modes of your choice to the ①, ②, ③ and ④ buttons. Learn more about how to use the WiZ app at wiz.world.

- 4. wall switch > ON always with the light colour stored on the remote control on button D (1)
ON-OFF-ON always with the light colour stored on the remote control button E (2)
remote control > ON with memory
WLAN > ON with memory

This product and batteries must be disposed of at a designated collection point for Electrical and Electronic waste. For more information, contact your local city office or the shop where you purchased the product.

1. Boutons WiZmote

- A. MARCHÉ
- B. ARRÊT
- C. Veilleuse
- D. Mode d'éclairage préféré 1
- E. Mode d'éclairage préféré 2
- F. Mode d'éclairage préféré 3
- G. Mode d'éclairage préféré 4
- H. Réglage de la luminosité

2. Modes d'éclairage préférés par défaut

Dans le système WiZ, chaque lampe appartient à une pièce, que vous sélectionnez lors de la configuration de la lampe dans notre application. Vous pouvez choisir parmi plusieurs types de pièces (par exemple « Cuisine » ou « Chambre »). Pour chaque type de pièce donné, WiZ propose un ensemble de 4 modes d'éclairage préférés, adoptés par défaut par toutes les lampes placées dans la pièce. Vous pouvez basculer rapidement entre les 4 modes avec les boutons ①, ②, ③ et sur votre WiZmote.

Ce produit, ainsi que les batteries, doit être éliminé dans un point de collecte désigné pour les déchets électriques et électroniques. Pour plus d'informations, contactez votre mairie locale ou le magasin où vous avez acheté le produit.



1. Przyciski WiZmote

- A. WŁĄCZENIE
- B. WYŁĄCZENIE
- C. Światło nocne
- D. Tryb Ulubione światło 1
- E. Tryb Ulubione światło 2
- F. Tryb Ulubione światło 3
- G. Tryb Ulubione światło 4
- H. Regulacja jasności

2. Domyślne, ulubione tryby światła

W systemie WiZ, każda lampa jest przypisana do pokoju, wybranego podczas ustawiania lampy w naszej aplikacji. Dostępnych do wybrania jest kilka typów pokoi (np. "Kuchnia" lub "Sypialnia"). Dla każdego danego typu pokoju, WiZ udostępnia zestaw 4 ulubionych trybów światła, zaadoptowanych domyślnie przez wszystkie lampy umieszczone w pokoju. Pomędzy 4 trybami można szybko przełączyć przyciskami ①, ②, ③ i ④ w WiZmote.

3. Dostosowane, ulubione tryby światła

Aplikacja WiZ umożliwia także edycję ulubionych trybów światła w pokojach, przypisując wybrane tryby światła do przycisków ①, ②, ③ i ④. Więcej informacji o tym, jak używać aplikacji WiZ, można uzyskać pod adresem wiz.world.

- 4. Przełącznik ścienny > ON zawsze jasny kolor na pilocie na przycisku D (1)
ON-OFF-ON zawsze jasny kolor na pilocie na przycisku E (2)
pilot > ON z pamięcią
WLAN > ON z pamięcią

Ten produkt i baterie należy usunąć do wyznaczonego punktu zbiórki odpadów elektrycznych i elektronicznych. W celu uzyskania dalszych informacji, należy się skontaktować z lokalnym urzędem miejskim lub ze sklepem w którym produkt został zakupiony.

1. WiZmote-Tasten

- A. An
- B. Aus
- C. Nachtlicht
- D. Favoriten-Beleuchtungsmodus 1
- E. Favoriten-Beleuchtungsmodus 2
- F. Favoriten-Beleuchtungsmodus 3
- G. Favoriten-Beleuchtungsmodus 4
- H. Helligkeitsanpassung

2. Standardmäßige Favoriten-Beleuchtungsmodi

Im WiZ-System gehört jede Lampe zu einem Raum; diesen wählen Sie bei der Einrichtung der Lampe in unserer App. Dabei stehen verschiedene Raumtypen zur Auswahl bereit (z. B. „Küche“ „Schlafzimmer“ usw.). Für jeden Raumtypen bietet WiZ eine Auswahl von 4 Favoriten-Beleuchtungsmodi, die standardmäßig von allen Lampen im Raum übernommen werden. Mit den Tasten ①, ②, ③ und ④ an Ihrer WiZmote können Sie schnell zwischen den 4 Modi umschalten.

3. Angepasste Favoriten-Beleuchtungsmodi

Zudem ermöglicht Ihnen die WiZ-App die Bearbeitung Ihrer Favoriten-Beleuchtungsmodi in Ihren Räumen; dabei können Sie die gewünschten Beleuchtungsmodi den Tasten ①, ②, ③ und ④ z uweisen. Erfahren Sie unter wiz.world mehr über die Verwendung der WiZ- App.

- 4. Wandschalter > ON immer mit der Lichtfarbe, die auf der Fernbedienung auf Taste D (1) gespeichert ist
ON-OFF-ON immer mit der Lichtfarbe, die auf der Fernbedienung auf Taste E (2) gespeichert ist
Fernbedienung > ON mit Memoryfunktion
WLAN > ON mit Memoryfunktion

Dieses Produkt sowie Batterien/Akkumulatoren müssen bei einer speziellen Sammelstelle für elektrische und elektronische Abfälle entsorgt werden. Weitere Informationen erhalten Sie von Ihrer Stadtverwaltung oder bei dem Laden, bei dem Sie das Produkt erworben haben.

1. Tasti WiZmote

- A. ON
- B. OFF
- C. Luce notturna Modalità
- D. luce preferita 1 Modalità
- E. luce preferita 2 Modalità
- F. luce preferita 3 Modalità
- G. luce preferita 4
- H. Regolazione luminosità

2. Modalità luce preferita predefinita

Nel sistema WiZ, ogni lampada appartiene ad una stanza, che viene selezionata durante la configurazione della lampada nell'app. Sono disponibili vari tipi di stanza tra cui scegliere (ad esempio, "Cucina" o "Stanza da letto"). Per ogni tipo di stanza, WiZ fornisce un set di 4 modalità luce preferita, adottata per impostazione predefinita da tutte le lampade situate nella stanza. È possibile commutare rapidamente tra le 4 modalità con i tasti ①, ②, ③ e ④ su WiZmote.

3. Modalità luce preferita personalizzata

L'app WiZ consente inoltre di modificare le modalità luce preferite nelle stanze, assegnando le modalità desiderate ai tasti ①, ②, ③ e ④. Per ulteriori informazioni sull'usodell'app WiZ, consultare wiz.world.

- 4. Interruttore posto sul muro > ON sempre con il colore della luce memorizzato sul telecomando al pulsante D (1)
ON-OFF-ON sempre con il colore della luce memorizzato sul telecomando al pulsante E (2)
telecomando > ON con le impostazioni in memoria
WLAN > ON con le impostazioni in memoria

Il prodotto e le batterie devono essere smaltite in un punto di raccolta designato per i rifiuti elettrici ed elettronici. Per ulteriori informazioni, contattare gli enti locali o il rivenditore presso il quale si è acquistato il prodotto.

1. Tlačítka na dálkovém ovladači WiZmote

- A. ZAP.
- B. VYP.
- C. Noční světlo
- D. Režim oblíbeného osvětlení 1
- E. Režim oblíbeného osvětlení 2
- F. Režim oblíbeného osvětlení 3
- G. Režim oblíbeného osvětlení 4
- H. Úpravy jasu

2. Výchozí režimy oblíbeného osvětlení

V systému WiZ patří každá lampa k některé místnosti, kterou vyberete při nastavování lampy v naší aplikaci. Můžete vybrat z řady typů místností (například „Kuchyně“ nebo „Ložnice“). Pro každý typ místnosti nabízí WiZ 4 režimy oblíbeného osvětlení, kterými ve výchozí konfiguraci řídí všechny lampy umístěné v místnosti. Tyto 4 režimy lze rychle přepínat pomocí tlačítek ①, ②, ③ a ④ na dálkovém ovladači WiZmote.

3. Přizpůsobené režimy oblíbeného osvětlení

V aplikaci WiZ lze rovněž upravovat vaše režimy oblíbeného osvětlení ve vašich místnostech a přiřazovat vybrané režimy osvětlení tlačítkům ①, ②, ③ a ④. Další pokyny pro používání aplikace WiZ najdete na webu wiz.world.

- 4. Nástěnný vypínač > ON (ZAP) vždy s barvou světla uloženého v dálkovém ovládání pomocí tlačítka D (1)
ON-OFF-ON (ZAP-VYP-ZAP) vždy s barvou světla uloženého v dálkovém ovládání pomocí tlačítka E (2)
dálkové ovládání > ON (ZAP) s pamětí
WLAN > ON (ZAP) s pamětí

Tento výrobek a baterie musí být zlikvidovány v určené sběrně elektronického a elektrického odpadu. Další informace vám poskytnou místní orgány nebo prodejce, u kterého jste produkt zakoupili.

1. Κουμπιά WiZmote

- A. ON
- B. OFF
- Γ. Φως νυκτός
- Δ. Αγαπημένη λειτουργία φωτισμού 1
- E. Αγαπημένη λειτουργία φωτισμού 2
- ΣΤ. Αγαπημένη λειτουργία φωτισμού 3
- Z. Αγαπημένη λειτουργία φωτισμού 4
- H. Ρύθμιση φωτεινότητας

2. Προεπιλεγμένες αγαπημένες λειτουργίες φωτισμού

Στο σύστημα WiZ, κάθε λάμπα ανήκει σε ένα δωμάτιο, το οποίο επιλέγετε κατά τη ρύθμιση των παραμέτρων της λάμπας στην εφαρμογή μας. Υπάρχουν αρκετοί διαθέσιμοι τύποι δωματίων, μεταξύ των οποίων μπορείτε να επιλέξετε (π.χ. «κουζίνα» ή «μπάνιο»). Για κάθε τύπο δωματίου, η WiZ παρέχει ένα σετ 4 αγαπημένων λειτουργιών φωτισμού, που είναι ενεργοποιημένες από προεπιλογή σε όλες τις λάμπες που είναι τοποθετημένες στο δωμάτιο. Με τη βοήθεια των κουμπιών ①, ②, ③ και ④ στο WiZmote σας μπορείτε να μεταβείτε γρήγορα από τη μια λειτουργία στην άλλη.

3. Προσαρμοσμένες αγαπημένες λειτουργίες φωτισμού

Η εφαρμογή WiZ σας επιτρέπει επίσης να τροποποιήσετε τις αγαπημένες σας λειτουργίες φωτισμού στα δωμάτιά σας και να εκχωρήσετε λειτουργίες φωτισμού της επιλογής σας στα κουμπιά ①, ②, ③ και ④. Μάθετε περισσότερα σχετικά με τον τρόπο που μπορείτε να χρησιμοποιήσετε την εφαρμογή WiZ στη διεύθυνση [wiz.world](#).

4. Διακόπτης τοίχου > ON πάντα με το χρώμα του φωτισμού που έχει αποθηκευτεί στο τηλεχειριστήριο στο κουμπί D (1) ON-OFF-ON πάντα με το χρώμα του φωτισμού που έχει αποθηκευτεί στο τηλεχειριστήριο στο κουμπί E (2)

τηλεχειριστήριο > ON βάσει της τελευταίας αποθηκευμένης ρύθμισης
WLAN > ON βάσει της τελευταίας αποθηκευμένης ύθμισης

 Η απόρριψη αυτού του προϊόντος και των μπαταριών πρέπει να πραγματοποιείται σε καθορισμένο σημείο συλλογής για ηλεκτρικά και ηλεκτρονικά απόβλητα. Για περισσότερες πληροφορίες, επικοινωνήστε με τον τοπικό σας αντιπρόσωπο ή το κατάστημα, από το οποίο προμηθευτήκατε το προϊόν.

1. WiZmote gombok

- A. BE
- B. KI
- C. Éjjeli fény
- D. 1. kedvenc világítási mód
- E. 2. kedvenc világítási mód
- F. 3. kedvenc világítási mód
- G. 4. kedvenc világítási mód
- H. Fényerő-szabályozó

2. Alapértelmezett kedvenc világítási módok

A WiZ rendszerben minden lámpa egy szobához tartozik, amit kiválaszthat, miközben beállítja a lámpát az alkalmazásunkban. Több szobafajta is elérhető, melyek közül választhat (pl. „Konyha” vagy „Hálószoba”). Minden megadott szobatípushoz a WiZ felajánl 4 kedvenc világítási módot, melyet alapértelmezettként elment minden lámpa a szobában. Gyorsan válthat a 4 üzemmód közül az ①, ②, ③ és ④ gombokkal a WiZmote-ról.

3. Egyedi kedvenc világítási módok

A WiZ alkalmazással módosíthatja is kedvenc világítási módjait a szobákban, így a kiválasztott világítási módokat rendelheti az ①, ②, ③ és ④ gombokhoz. Ismerje meg közelebbről a WiZ alkalmazás használatát a [wiz.world](#) oldalán.

4. Fali kapcsoló > ON – mindig a távirányító „D” (1) gombján tárolt színű fénnel.
ON-OFF-ON – mindig a távirányító „E” (2) gombján tárolt színű fénnel
távirányító > ON – memóriával
Wi-Fi > ON – memóriával

 A terméket és az elemeket az elektromos és elektronikus hulladékok gyűjtésére kijelölt gyűjtőponton kell leadni. További információért keresse helyi irodánkat, vagy az üzletet, ahol a terméket megvásárolta.

1. Butoane WiZmote

- A. PORNIT
- B. OPRIT
- C. Iluminat pe timp de noapte
- D. Mod preferat 1
- E. Mod preferat 2
- F. Mod preferat 3
- G. Mod preferat 4
- H. Ajustare strălucire

2. Moduri de iluminat favorite implicite

În sistemul WiZ fiecare lampă aparține unei camere, așa cum o selectați atunci când setați lampa prin intermediul aplicației. Aveți posibilitatea de a alege între diferite tipuri de camere (de exemplu „Bucătărie” sau „Dormitor”). Pentru fiecare tip de cameră disponibil, WiZ pune la dispoziție 4 moduri de iluminare preferate, ce sunt folosite implicit de toate lămpile din acea cameră. Puteți schimba rapid dintr-un mod în altul apăsând butoanele ①, ②, ③ și ④ de pe telecomanda WiZmote.

3. Moduri de iluminare preferate personalizate

Aplicația WiZ vă dă de asemenea posibilitatea de a personaliza modulile de iluminare preferate în camerele dvs, corelând modulile de iluminare alese de dvs. cu butoanele ①, ②, ③ și ④ Aflați mai multe despre cum utilizați aplicația pe [wiz.world](#).

4. Întrerupător de perete > ON întotdeauna cu culoarea luminii memorată pe butonul D (1) al telecomenzii
ON-OFF- ON întotdeauna cu culoarea memorată pe butonul E (2) al telecomenzii
telecomandă > ON cu setarea memorată
WLAN > ON cu setarea memorată

 Acest produs și bateriile acestuia trebuie aruncate într-un punct de colectare autorizat pentru colectarea deșeurilor electrice și electronice. Pentru mai multe informații contactați biroul la nivel local sau magazinul de unde ați achiziționat produsul.

1. WiZmote'i nupud

- A. SEES
- B. VÄLJAS
- C. Oõvalgus
- D. Lemmik valguserežiim 1
- E. Lemmik valguserežiim 2
- F. Lemmik valguserežiim 3
- G. Lemmik valguserežiim 4
- H. Heleduse reguleerimine

2. Vaikimisi lemmik valguserežiimid

WiZ süsteemis kuulub iga lamp ruumi, mille te valite lambi seadistamisel meie rakenduses. Valida saab mitme ruumi tüübi vahel (nt „kõök” või „magamistuba”). Igale ruumitüübile pakub WiZ nelja lemmik valguserežiimi, mis on vaikimisi kõikidel ruumi kaigutatud lampidel. Saate nende nelja režiimi vahel kiiresti lülituda WiZmote'i nuppudega ①, ②, ③ ja ④.

3. Kohandatud lemmik valguserežiimid

WiZ rakendus võimaldab teil oma lemmik valguserežiime ruumides ka muuta, määrates seega teie valitud valguserežiimid nuppudele ①, ②, ③ ja ④. Uurige lähemalt WiZ rakenduse kasutamise kohta saidilt [wiz.world](#).

4. Seinalüliti > ON alati valguse värviga, mis on salvestatud kaugjuhtimispluti nupu D (1) alla
ON-OFF-ON alati valguse värviga, mis on salvestatud kaugjuhtimispluti nupu E (2) alla
Kaugjuhtimisplutt > ON koos mäluga
WLAN > ON koos mäluga

 Käesolev toode ja akud tuleb kõrvaldamiseks viia vastavasse elektriseadmete ja elektroonikajäätmete kogumispunkti. Lisateabe saamiseks pöörduge kohaliku omavalitsuse poole või kauplusse, kust te toote ostsite.

1. „WiZmote“ mygtukai

- A. „ON” (ijungta)
- B. „OFF” (išjungta)
- C. Naktinis apšvietimas Mėgstamas
- D. apšvietimo režimas 1 Mėgstamas
- E. apšvietimo režimas 2 Mėgstamas
- F. apšvietimo režimas 3 Mėgstamas
- G. apšvietimo režimas 4 Ryškumo
- H. reguliavimas

2. Numatytieji mėgstami apšvietimo režimai

WiZ sistemoje kiekviena lemputė priklauso patalpai, kurią pasirinksite, nustatydami lemputes mūsų programėlę. Galite rinktis keletą patalpų tipų (pvz.: „virtuvė” ar „miegamasis”). Kiekvienam pasirinktam patalpų tipui, WiZ numatė 4 mėgstamus apšvietimo režimus, pritaikytus pagal numatytuosius parametrus visoms patalpose išdestytoms lemputėms. Galite greitai perjungti 4 režimus ①, ②, ③ ir ④ „WiZmote” mygtukais.

3. Pritaikyti mėgstami apšvietimo režimai

WiZ programėlė taip pat leidžia jums redaguoti jūsų mėgstamus apšvietimo režimus savo kambariuose, priskirdami pasirinktus apšvietimo režimus ①, ②, ③ ir ④ mygtukams. Sužinokite daugiau, kaip naudotis WiZ programėle [wiz.world](#) paskyroje.

4. Sieninis jungiklis > ON visada su šviesos spalva, išsaugota nuotolinio valdymo sistemoje, mygtukas D (1)
ON-OFF-ON visada su šviesos spalva, išsaugota nuotolinio valdymo sistemoje, mygtukas E (2)
nuotolinis valdymas > ON su atmintimi
WLAN > ON su atmintimi

 Šis gaminys ir baterijos turi būti šalinamos paskirtose elektros ir elektronikos atliekų surinkimo punktuose. Norėdami gauti daugiau informacijos, kreipkitės į miesto administraciją ar parduotuvę, kurioje įsigijote gaminį.

1. Tipke daljinskog upravljača WiZmote

- A. Uključeno (ON) Isključeno
- B. (OFF)
- C. Noćno svjetlo
- D. Omiljen način osvjetljenja 1
- E. Omiljen način osvjetljenja 2
- F. Omiljen način osvjetljenja 3
- G. Omiljen način osvjetljenja 4
- H. Podešavanje jačine svjetla

2. Standardni omiljeni načini osvjetljenja

U sustavu WiZ, svaka lampa pripada jednoj prostoriji koju odabirete dok unosite postavke za lampu u našu aplikaciju. Na raspolaganju vam je odabir između nekoliko tipova prostorija (npr. „Kuhinja” ili „Spavaća soba”). Za svaki tip prostorije, WiZ vam nudi komplet od 4 omiljena načina osvjetljenja, koje prema standardu prihvaćaju sve lampe postavljene u prostoriji. Možete brzo prebacivati Biranjem tipaka ①, ②, ③ i ④ na vašem WiZmote upravljaču, možete brzo odabirati između 4 vrste svjetla.

3. Prilagođeni omiljeni načini osvjetljenja

Aplikacija WiZ vam također omogućuje da uredite svoje omiljene načine osvjetljenja u prostorijama, tako što vaš odabir načina osvjetljenja prenosi na tipke ①, ②, ③ i ④. Saznajte više o tome kako koristiti aplikaciju WiZ, na [wiz.world](#).

4. Zidni prekidač>ON uvijek sa svjetlom u boji pohranjenoj na daljinskom upravljaču, tipka D (1)
ON-OFF-ON uvijek u sa svjetlom u boji pohranjenoj na daljinskom upravljaču, tipka E (2)
Daljinski upravljač > ON s memorijom
WLAN > ON s memorijom

 Ovaj proizvod i baterije moraju se odlagati na za to određenom odlagalištu za električni i elektronički otpad. Za više Informacija, kontaktirajte lokalni gradski ured ili trgovinu u kojoj ste kupili proizvod.

3. Pielāgoti iecienītie apgaismojuma režīmi

WiZ lietotne ļauj rediģēt jūsu iecienītos telpu apgaismojuma režīmus, piešķirot jūsu izvēlētos apgaismojuma režīmus pogām ①, ②, ③ un ④. Uzziniet vairāk par WiZ lietotnes izmantošanu vietnē [wiz.world](#).

4. Sienas slēdzis > ON vienmēr ar gaišu krāsu, kas saglabāta uz tālvaldības pults pogas D (1)
ON-OFF-ON vienmēr ar gaišu krāsu, kas saglabāta uz tālvaldības pults pogas E (2)
tālvaldības pults > ON (ieslēgt) ar atmiņu
WLAN > ON (ieslēgt) ar atmiņu

 Šis izstrādājums un baterijas jālikvidē atkritumu savākšanas punktā, kas īpaši paredzēts elektriskajiem un elektroniskajiem atkritumiem. Lai saņemtu plašāku informāciju, sazinieties ar vietējo pilsētas biroju vai veikalu, kurā iegādājāties produktu.

1. WiZmote gumbi

- A. VKL.
- B. IZK.
- C. Nočna svetloba
- D. Priljubljeni način osvetlitve 1
- E. Priljubljeni način osvetlitve 2
- F. Priljubljeni način osvetlitve 3
- G. Priljubljeni način osvetlitve 4
- H. Prilagoditev svetlosti

2. Privzeti priljubljeni način osvetlitve

V WiZ sistemu vsaka svetilka pripada sobi, kar lahko izberete ko nastavljate svetilko v naši aplikaciji. Izberate lahko med številnimi vrstami sob (npr. "Kuhinja" ali "Kopalnica"). Za vsako podano vrsto sobe, WiZ nudi komplet 4 priljubljenih načinov osvetlitve, ki so kot privzeti nastavljeni na vseh svetilkah v sobi. Hitro lahko preklopite med 4 načini z gumbi ①, ②, ③ in ④ na vašem WiZmote daljinskem upravljalniku.

3. Priljubljeni načini osvetlitve po meri

WiZ aplikacija vam omogoča tudi urejanje vaših priljubljenih načinov osvetlitve v sobah, tako da dodeli načine osvetlitve po vaši izbiri gumbom ①, ②, ③ in ④. Več o tem, kako uporabljati WiZ najdete na [wiz.world](#).

4. Stensko stikalo > ON vedno s svetlo barvo, ki je shranjena na daljinskem upravljalniku pod gumbom D (1)
ON-OFF-ON vedno s svetlo barvo, ki je shranjena na daljinskem upravljalniku pod gumbom E (2)
daljinski upravljalnik > ON s spomina
WLAN > ON s spomina

 Ta izdelek in baterije morate odstraniti na določeni točki za zbiranje električnih in elektronskih odpadkov. Za več informacije stopite v stik z vašo lokalno mestno pisarno ali trgovino, kjer ste kupili izdelek.